



2019 Sportsman Modified Rules

DISCLAIMER:

The rules and/or **regulations** set forth herein are designed to provide for the orderly conduct of racing events and to establish minimum acceptable requirements for such events. These rules shall govern the condition of all events, and, by participating in these events, all participants are deemed to have complied with these rules. *No expressed or implied warranty of safety shall result from the publication of or compliance with these rules and/or regulations.* They are intended as a guide for the conduct of the sport and in no way a guarantee against injury or death to a participant, spectator, or official.

The race director shall be empowered to permit reasonable and appropriate deviation from any of the specifications herein or impose any further restrictions that in his opinion do not alter the minimum acceptable requirements. *No expressed or implied warranty of safety shall results from such alterations of specifications.* Any interpretation or deviation of these rules is left to the discretion of the officials. Their decision is final.

On occasion when situations arise that are not covered by written rules, special rulings may be put into effect by the Series of Track Officials. Once such rulings are acted upon, they *may* be added to the existing rules and/or procedures.

Contact Info:

RUSH Racing Series Directors: Vicki Emig & Mike Leone
4368 US 422, Pulaski, PA 16143
724-964-9300 (phone) 724-964-0604 (fax)
E-mail: info@rushracingseries.com

Travis Harry (Competition Director): 814-676-9997 or 814-758-5737 (after 5 PM).
E-mail: travisharry1123@gmail.com

Website: www.rushsportsmanmods.com
Like us on Facebook at www.facebook.com/rushsportsmanmods
Follow us on Twitter @RUSHSportMods

The following specifications shall be considered the "Official Rules and Specifications" for all events sanctioned by the RUSH Sportsman Modified Series.

All event procedural rules will fall under the RUSH Touring Series for Touring Series events or individual track procedural rules if classified as a RUSH Weekly Series event.

ELIGIBILITY:

New for 2019: ALL western Pennsylvania/eastern Ohio-based racers will be eligible for competition.

Drivers from outside western Pennsylvania/eastern Ohio will be *ineligible* to compete in the RUSH Sportsman Modified division if any one of the following apply:

- Driver is a full-time competitor in "410" Sprint Cars, Super Late Models, Block Modifieds or "358" Small Block Modifieds. Full-time equals 10 or more races in any of the above or combination of the above. Once driver reaches this point, he/she will lose accumulated RUSH points for the year and will be unable to compete in any RUSH-sanctioned event for the balance of the season.
- Driver is a top 5 point finisher in "410" Sprint Cars, Super Late Models, Big-Block Modifieds or "358" Modifieds in the past 2 seasons (excludes current season).
- Driver is a feature winner in "410" Sprint Cars, Super Late Models, Block Modifieds or "358" Small Block Modifieds in the past 2 seasons.

If a speedway drops their Modified division and the driver(s) elects not to participate in the division on a full-time basis at any other speedway, driver(s) may be deemed eligible at RUSH's discretion.

Final driver eligibility to be determined by RUSH Officials to ensure the intent, growth, and stability of the RUSH Sportsman Modified Division.

Note: Any driver that moves up to compete with Big-Block or "358" Modified class with a Sportsman-legal car on the same night the Sportsman Modified class is in competition at the same track or in the same region *may* receive a 500-point penalty and *may* be ineligible to compete in the next two RUSH-sanctioned events.

POINT FUNDS/MEMBERSHIPS:

Weekly Series (\$11,125 total paying 20 positions): 1. \$3,000 2. \$1,500 3. \$1,000 4. \$750 5. \$600 6. \$500 7. \$400 8. \$350 9. \$325 10. \$300 11. \$270 12. \$265 13. \$260 14. \$255 15. \$250. 16. \$240 17. \$230 18. \$220 19. \$210 20. \$200

Drivers must be a Weekly Series member to be eligible for point fund monies (\$125 annual membership). Points will be accumulated for drivers' best 12 finishes throughout the season at RUSH-sanctioned events only. POINTS ARE NOT RETROACTIVE. YOUR POINTS WILL NOT COUNT UNTIL MEMBERSHIP IS COMPLETED & PAID! *RUSH reserves the right to decline a membership or revoke a membership at any time.*

Touring Series (Point fund TBA; paying 10 positions)

You must be a member of the Touring Series (\$125 membership or \$225 for both) to be eligible for points and point fund monies. Points will be accumulated for all Tour events. Tour Events postponed to the following year will not count for current year Tour points. Although it would not be the intention of the Series, in the event of unforeseen extreme circumstances Touring point fund could be adjusted.

"Futures Cup":(\$300 to-win paying 10 positions):

Must be a Weekly member, not be older than 19 years of age, and not be a prior "Futures Cup" Champion to be eligible for points and point fund monies. Those 18 & 19 cannot have more than 1 prior season of Sportsman Modified experience (8 or more events = 1 season). No headlining division experience permitted. Those under 16 should verify eligibility to race at each individual track. Points are based off Weekly Series Championship.

"Wheelman" Bonus Event Series: (\$300 to-win paying 5 positions):

You must be a Weekly or Touring Series member to be eligible for point fund. A race will be run nightly at Sharon Speedway for drivers that have never won a feature event in a full-size race car (excluding Mini Stocks). Once a driver wins a feature he or she will no longer be eligible to compete in the "Wheelman" events; however, will keep points accumulated until that point.

Insurance: Members receive \$100,000 excess participant accident insurance. Policy period is 1/1/19-1/1/20; however, coverage does not begin until membership is completed and paid. RUSH insurance benefits will cover the member driver after the tracks participant accident limit and driver's individual health insurance benefits are exhausted, but only at RUSH-sanctioned events.

Manufacturers Night: A Manufacturers Night will be at Sharon Speedway on a date TBA where several thousands of dollars of products will be given away. Driver's car MUST be 100% RUSH legal, attempt to compete, and not have competed in a non RUSH-sanctioned Sportsman/602 Crate Modified event that conflicted with a RUSH-sanctioned Sportsman Modified event at any time in order to be eligible for the giveaways.

Point System:

The following system will be utilized for all of the above programs: 1. 100 2. 98 3. 96 4. 94 5. 92 6. 90 7. 89 8. 88 9. 87 10. 86 11. 85 12. 84 13. 83 14. 82 15. 81 16. 80 17. 79 18. 78 19. 77 20. 76 21. 75 22. 74 23. 73 24. 72 25 & any other starter 71. Drivers attempting to race, but not starting the feature will receive 70 show-up points. On Weekly Series events, all drivers will receive 12 "bonus" points provided there are 12 or more cars. If there are less than 12 cars, the car count bonus will be based on number of competing cars signed in.

Postponed feature events will revert back to the weekend they were initially scheduled for with the exception of an event that has been pushed to the following year.

Awards Banquet/Point Funds/Tie-Breakers: A RUSH Racing Series Awards Banquet will be held at the conclusion of the season (mid to late January). Drivers/Car Owners are expected to attend or have a pre-determined representative to accept awards. Unclaimed payoffs and awards will be mailed at a later date.

In the event of a tie for any of the above championships, tiebreaker will be determined by the driver with the most wins (high point scores for Weekly & Chase) followed by most second place finishes, etc. until the tie is broken. If a tie happens in any other position, the tie will remain with point fund monies added up between the tied positions and split equally.

AGE REQUIREMENTS:

Age requirements vary by speedway. It is the team's responsibility to verify eligibility regardless if it's a Touring Series or Weekly Series event.

PAYOFF:

While the RUSH Series makes every effort to sanction and/or schedule events at reputable facilities, and has never had any problems with purse payouts to competitors, please be aware that RUSH cannot be responsible in the event that a promoter fails to make purse payments, or pays with checks which are later found to be not negotiable. This notice includes the possible situation where a promoter might pay the full purse to RUSH with a check that is later to be insufficient. RUSH will not pay purse payments until promoter's check clears. When speedway and/or promoter's check clears, RUSH will then guarantee proper purse payments, subject only to resolution of protests, or technical infractions.

RUSH Series Officials reserve the right to hold payoff(s) of driver(s) selected for technical inspection(s). Payoffs will only be released to 1099 recipient(s) of selected driver(s) upon final technical inspection results and/or appeal process providing said inspection complies with RUSH Technical Rules. In the event selected driver(s) technical inspection results does not comply with RUSH Technical Rules and appeals process has been exhausted, said payoff will be adjusted and distributed to other competing racers.

RUSH Series Officials also reserves the right to withhold a driver's payoffs in the event said driver has a debt to the Series.

RUSH will mail the person or corporation designated on the membership form any purse or point fund payoffs. In the event of a car owner change, a new membership form must be completed. In the event of a car owner change midseason, point fund payoffs would be prorated based on performance in all point funds (based on the program's specs, i.e. best 12 finishes) other than Touring, which has a separate driver/owner point fund. A Form 1099 MISC by January 31 of the following year will be sent to the person or corporation that earned a minimum of \$600.00 during the year for any monies paid by Great Crate Racing Northeast, LLC D/B/A RUSH Racing Series, as required by the IRS.

SERIES' SPONSOR PRODUCT CONTINGENCIES AND DECALS:

The RUSH Sportsman Modified Series decal is required on both sides of the car. Sponsor decal package/logos link for body graphics usage is located at the bottom of the website sponsor page.

Required RUSH Series sponsor decals must be displayed prominently on both sides of the car at all events. Your car may be checked for decals at any time.

Certain product manufacturers award contingency product and/or money. The awards are dependent upon the manufacturers decal being displayed on the racecar. To be eligible to receive the award from the manufacturers concerned, it is your responsibility to ensure that the correct decal is affixed to your racecar.

Please be aware that the Series' has no responsibility to pay the award, but only to provide the participant with the certificate previously agreed upon and contracted with the Manufacturer.

Contingency prizes will be awarded to the car owner of record. It is the responsibility of the participant to redeem contingency prize certificates and/or product by expiration date on certificate. Series will not be responsible for delivery and/or transportation of contingency prizes that were not available for pick-up on event date.

Keep in mind that sponsors only put money into the Series to gain exposure for their products; no exposure will eventually mean no money and smaller championship programs.

RUSH Racing Series Officials may refuse to allow a participant to compete in an event if it is determined at their discretion that any advertising and/or sponsorship or similar agreement is **detrimental** to the sport, the RUSH Racing Series, or the event promoter for any reason, including the image of the sport.

CONDUCT:

- A.) General** - All drivers crew chief, car owner, crew member and/or team representative agree to act in a professional manner as determined by RUSH Officials. The professional manner includes, but is not limited to verbal representation, written representation, any representation that may represent the RUSH Racing Series, sport of Late Model racing and/or motorsports in general and/or any affiliates. Verbal abuse may result in an immediate disqualification from the event. Repeated violation(s) may also warrant fine and/or suspension.
- B.)** While we recognize your right to express opinions, good or bad, on social media, drivers and crew members should be advised that threats against officials, other drivers or crew members will not be tolerated. Any action by a driver or crew which appears to be the execution of a threat will result in penalties via suspensions and/or fines against the driver and/or car owner. The driver or car owner will be held responsible for the actions or members of his or her crew.
- C.)** Any driver/owner that disparages RUSH in any publication (including messages boards, social media, etc.) may be suspended for a minimum of one event and/or fined.
- D.)** All drivers must arrive at Series races in a timely manner so that they may participate in the entirety of the racing event.
- E.)** No driver will be permitted to compete and/or participate while under the influence of any alcoholic beverages and/or illegal substances. If a driver is found to be participating in such a manner, an immediate suspension will be invoked.
- F.)** Any driver, during an event; a competitor, crew chief, car owner, crew member and/or team representative may be requested to report to the RUSH Command Center for consultation with RUSH officials. The request may be communicated over the one-way radio and/or verbally. Failure to comply with the request will be subject to fine and/or suspension and/or any other action deemed appropriate by RUSH Officials.
- G.)** The use of any signaling lights, devices or apparatus by crew members is not permitted. Violations may cause the driver to be disqualified from the race or the night.

The RUSH Racing Series is a professional organization and will conduct itself so in its dealings with everyone, including fans, drivers, team members, Series sponsors, team Sponsors, tracks and the media. The Series therefore expects the same from its drivers, team members and team sponsors. The Series organizers and officials therefore reserve the right to take disciplinary action against anyone who brings the Series into disrepute by their actions, either on or off the track.

In the event of any felony conviction of a driver, team member or team sponsor, the disciplinary action shall be a minimum one-year ban from the Series, beginning with the date of the conviction, or, the date of the completion of any incarceration subsequent to said conviction, whichever date shall last occur.

Disciplinary action may also include, but is not limited to, the right of the Series organizers and officials to suspend either temporarily, or permanently, any driver, team member or team sponsor whose actions, in the sole opinion and discretion of the Series organizers and officials, may have resulted in, or may result in, harm or detriment to the RUSH Racing Series events.

The Series organizers and officials also reserve the right to request the removal of any derogatory or distasteful statements on any racecar or hauler. Failure to comply with this request for removal may result in disqualification from some or all of the RUSH Racing Series events.

Participants grant and assign to RUSH Racing Series, its affiliates and RUSH Racing Series Sponsors the non-exclusive rights and authority to use my image and likeness, including my name, nickname, initials, picture, photograph, animation, persona, autograph/signature (including facsimiles thereof), voice, biographical information, and/or any and all other identifying characteristics, including the image of my vehicle, whether portrayed in still or action pictures, drawings, or other artistic renderings, in connection with my participation in RUSH Racing Series Events and for any and all uses or purposes that publicize and promote RUSH Racing Series or any of its affiliates in any way in any and all media or formats.

ENVIRONMENTAL WARNING:

- A.) **Any driver or crewmember** found to be altering, by means of contaminating the racing surface or pit area or racing entrances and/or staging or technical inspection areas or **ANY** part of the event grounds or properties and nearby driveways will be **disqualified**. The local authorities and/or agencies may be notified and the violator(s) and their information may be turned over to these authorities at that time.
- B.) **No race cars or vehicles** including, but not limited to **race trailers, or support vehicles or trailers** will be allowed to carry or conceal, in marked, unmarked or using any form of misrepresentation of jugs or bottles or carrying devices of any type (with concerns to chemicals), for the purpose of altering, conditioning or changing a tire's baseline settings (from its original factory set baseline settings) will be allowed in or around the/any RUSH Series Event/s. All local authorities and applicable agencies may be called and the violators and their information will be turned over to these authorities at that time.

TECHNICAL RULES & REGULATIONS

It is ultimately the obligation of each participant to ensure that their conduct and equipment complies with all of the applicable rules, as they may be amended from time to time; any amendments supersede any previous rules regarding any technical and/or aspect. An amendment is effective upon the date of the publication of the amendment regardless of when a competitor receives the actual notice.

Any new components, including engine components, suspension components, body designs, frame designs and/or components of any type utilized in competition must be approved by RUSH Officials prior to being introduced into competition.

ENGINES:

- A.) The General Motors (GM) Engine part number #88958602/19258602 is the only engine permitted in all RUSH Sportsman Modified events.
- B.) All engines are to remain sealed from the factory. These engines are sealed at the intake manifold, cylinder heads, front cover and oil pan with special GM twist off bolts or cap seals. The original factory seals (bolt type or cap seal) must remain unaltered. Tampering, removal, or modifications of any type and/or broken factory seals, bolt type or cap seal, will not be permitted and will result in an immediate disqualification from the event (loss of points and money). The engine may be impounded immediately for further inspection.
- C.) The exception to this will only be in the event a rebuild/repair is required. This rebuild/repair must be authorized by the RUSH Racing Series, at which time the engine may be repaired/ or possibly rebuilt providing all guidelines and specifications set forth in the GM Technical Manual #88958668 are met; otherwise the GM Engine must remain unaltered in any way.
- D.) Only RUSH or DIRTcar seals will be accepted in the event of an engine rebuild/repair.
- E.) Engines must be sealed in all of the above locations with either the "original" GM twist off bolt heads or cap seals, RUSH or DIRTcar seal tags, or a combination of the "original" GM twist off bolts or cap seals, and/or RUSH or DIRTcar seal tags.
- F.) The sealed engines must remain intact and not be tampered with; **any seals** that have been tampered with, removed, or modified, and/or broken will make the engine illegal and will result in an immediate disqualification from the event (loss of points and money). The engine may be impounded immediately for further inspection. Modifying any internal engine parts or changing the parts from stock as delivered sealed from the factory will result in disqualification for the night's event (loss of points and money), loss of all Series points to date in the division the infraction occurred in, suspension from all RUSH-sanctioned Series competition for 365 days, fined \$1,000, and an indefinite probation; penalties apply to both driver and car owner.
- G.) The permitted crate engines must not be altered, modified, or changed from the GM specifications set forth in the GM Technical Manual #88958668; no changes are allowed to the engine- intake manifold, heads, valve covers, front cover, oil pan, harmonic balancer, or any other part or parts on or in the engine.

- H.) Only GM parts will be permitted for rebuild/repair work excluding engine bearings. Replacement engine bearings can be OEM replacement. Replacement bearings must be the same dimensions as the factory GM bearing plus/minus .002 in all dimensions. NO bearing coatings allowed!
- I.) Only GM Crate Engine specific valve springs may be used for replacement and/or repair, Part Number # 10212811 for singles or part number 19154761 for kit of 16 springs. Valve springs may be shimmed to GM manual specs only.
- J.) RUSH GM Crate Engine rebuild/repairs must be authorized by RUSH Racing Series. RUSH GM Crate Engine rebuild/repair procedure works as follows:
1. RUSH authorized rebuild/repair center must complete the RUSH Racing Series Engine Seal Request, Engine Parts Release, and Engine Owner & Authorized Rebuild/Repair Facility Agreement forms must be completed in their entirety and faxed/e-mailed to RUSH Racing Series office at 724-964-0604 or info@rushingseries.com to receive permission from RUSH officials for engine to be rebuilt or repaired.
 2. Only RUSH Racing Series authorized engine rebuild/repair facilities may be utilized. The list of RUSH authorized engine rebuild/repair facilities is available on the RUSH Sportsman Modified website under the engine tab.
 3. Based on the estimate and the detail of the rebuild/repair, RUSH Racing Series Officials will determine if the rebuild/repairs may be made or if a new engine must be purchased.
 4. Upon completion of the rebuild/repair(s) the engine must be 'resealed' using RUSH seals before being released for competition.
 5. All engine information regarding rebuild/repairs and/or engine introduction must be retained by RUSH Authorized Engine Repair Facility and turned into RUSH office at 4368 US 422, Pulaski, PA 16143 to be recorded into rebuilt/repared engine database, which includes the engine owner, driver at time of rebuild/repair, engine serial number, repair, type of repair and/or what type of service was performed to any engine, along with RUSH seal numbers and specific location of seals.
 6. The opportunity for an engine to be rebuilt/repared will be at the sole discretion of RUSH Racing Series Directors upon reviewing RUSH authorized rebuild/repair center's RUSH "Seal Request and "Engine Parts Release" forms.
 7. In the event a repair must be made to an engine scheduled to compete in consecutive RUSH-sanctioned events or if RUSH seals cannot be obtained in time for competition in a single event, engine owner and or competitor "must" have authorized RUSH engine repair facility of their choice contact RUSH Series Directors to receive permission and instructions on obtaining "approved" temporary seals in order for engine to compete. RUSH Competition Director can also install "approved" temporary seals in this situation. Temporary seals will "only" be permitted on repaired engines for events that are designated by RUSH Series Directors.
- K.) Engine's GM serial number and when applicable RUSH or DIRTcar build certification number must be clearly visible to Series' or track technical inspectors.
- L.) RUSH Racing Series Officials reserve the right to inspect, exchange and/or confiscate any GM Crate engine, or other specified engine component. Refusal to surrender an engine or other engine part for inspection, exchange or confiscation, will result in disqualification for the night's event (loss of points and money), loss of all Series points to date in the division the infraction occurred in, suspension from all RUSH-sanctioned Series competition for 365 days, fined \$1,000, and an indefinite probation; penalties apply to both driver and car owner.
- M.) ANY VIOLATION OF THE ENGINE RULES AND/OR FACTORY SPECS INSIDE THE SEALING SYSTEM OF THE ENGINE WILL result in disqualification for the night's event (loss of points and money), loss of all Series points to date in the division the infraction occurred in, suspension from all RUSH-sanctioned Series competition for 365 days, fined \$1,000, and an indefinite probation; penalties apply to both driver and car owner.

After the suspension period, the driver and/or car owner can only compete in Series events with an engine equipped with original factory GM sealing bolts or cap seals, or RUSH seal tags.

For subsequent violations in regard to any illegal modification to any GM Performance Parts Crate Engine, an indefinite suspension may be issued.

- N.) Any violation of the engine rules and/or factory specs outside the original GM twist off bolt heads or cap seals and/or permitted Series seal tags on the engine will result in the driver and car being disqualified from that event (loss of points and money). Multiple infractions outside the sealing system will result in the penalties stated in the "Multiple Infractions" section of the rules.
- O.) The engine must be centered in the front of the chassis and placed in an upright position.
- P.) Engine set back will be as follows; Minimum is 56"-inches and a Maximum of 66"-inches with a tolerance of ½"-inch (+/-). The setback will be measured from the centerline of the front axle to the rear machined surface of the engine bell housing.

ENGINE PROTESTS/SELECTION:

1. Any RUSH-sanctioned race track and/or RUSH Series Director(s) are authorized to call for an engine inspection or tear down *at any time*. Tear down and inspection will be performed by RUSH Tech/Competition Director. If this happens, Track/Series will remove engine at race track and impound until inspection day can be arranged for all parties involved. (See paragraph number five for procedures if selected car is to race in successive events.)
2. The protest fee for a complete teardown of an engine that finishes the A main in the top five is \$2,000, and must be made by a driver/owner that finishes in the top five. \$300 of protest fee will go to Series or Track and the remaining \$1,700 will go to the winner of the protest.
3. The protest fee for a partial teardown of an engine that finishes the A main in the top five is \$1,500, and must be made by a driver/owner that finishes in the top five. \$300 of protest fee will go to Series or Track and the remaining \$1,200 will go to the winner of the protest. A partial teardown will include the following: cam profiled along with the timing components, lifters, and cylinder heads verified.
4. Protest and fee in cash must be made to a RUSH Tech Inspector, Race Director, or Track Tech Inspector within 15 minutes of the checkered flag of the feature. Protest cannot be withdrawn once it has been declared.
5. At any time an engine is protested and driver/car owner accepts protests and agrees to tear down, the engine being protested must be removed immediately and impounded by Series/Track. Protested engine will be sealed by RUSH Official or person(s) appointed by RUSH to insure that it has not been tampered with, and to verify engine's identity. Any refusal to permit engine confiscation will result in disqualification for the night's event (loss of points and money), loss of all Series points to date in the division the infraction occurred in, suspension from all RUSH-sanctioned Series competition for 365 days, fined \$1,000, and an indefinite probation; penalties apply to both driver and car owner.
6. *If the protested car wishes to race in successive RUSH-sanctioned events within 72 hours (three days) the following will apply ONLY at the discretion of RUSH:* RUSH Series Officials reserve the right and also grants the right to RUSH-sanctioned speedway tech officials to seal or otherwise identify the protested engine to allow the car to compete in successive events within 72 hours (three days). Further postponement of tear-down will be at the discretion of RUSH Directors/Officials. The driver and/or owner has the option whether to surrender the engine on the night it's protested or have it identified and retained for the successive races. However, if the driver chooses to compete with the engine after its selection for tear down, and that engine is found to be out of compliance with RUSH Technical/Engine rules, the driver will be disqualified from all races entered after the engine was protested, in addition to the race when engine was protested. RUSH *may* assess penalties for *each* race in which the selected engine was used after its selection, if it is found to be illegal. If the engine is found to comply with all applicable rules, then driver/owner will be awarded all money and points earned for each event.
7. At this time, the feature finish will be frozen until inspection is complete. In the event of a disqualification, finishing position, points and monies would be adjusted accordingly.
8. Failure and/or refusal to tear down an engine and/or for your race car to be inspected by Series at any time will result in disqualification for the night's event (loss of points and money), loss of all Series points to date in the division the infraction occurred in, suspension from all RUSH-sanctioned Series competition for 365 days, fined \$1,000, and an indefinite probation; penalties apply to both driver and car owner.
9. Inspection location will most likely be at RUSH office/garage located at 4368 Route 422, Pulaski, PA 16143. Although other inspection locations could be selected. There will be no dispute over RUSH Official's choice of location.
10. Driver and/or car owner and one other representative of the team will be allowed in the tech area during the engine teardown. Only one representative from the team protesting the engine will be allowed in the tech area during the engine teardown. Additional attendees must be approved by RUSH pursuant to a written request. Protestor and protested driver and/or car owner along with the confiscated sealed engine and/or parts must be present at predetermined location. All parties must remain present during the entire teching procedure.
11. Note: All removed original GM bolts or cap seals, RUSH and/or DIRTcar Seals must be returned immediately to the RUSH Office.
12. Engine infractions "within the bolts" will result in disqualification for the night's event (loss of points and money), loss of all Series points to date in the division the infraction occurred in, suspension from all RUSH-sanctioned Series competition for 365 days, fined \$1,000, and an indefinite probation; penalties apply to both driver and car owner.
13. In the event that the series confiscates engine, for inspection, and said engine is found to be legal, and comply with the all the rules, the "Series" will provide a full GM gasket set, and the seals to reassemble engine at no charge to the authorized rebuilder and engine owner. If engine is protested by another racer for inspection, the engine owner is responsible for all expenses required for reassembly.

Carburetor / Air Cleaner

A.) Only one (1) 650 cfm Holley carburetor, Part Number 4777 or 80777 or Holley HP Carburetor Part Number 80541-1 or 80541-2 will be permitted.

B.) All engines and all components must remain in their original configuration and form as purchased and/or delivered from the factory. Any changes will result in disqualification from the event. Any alterations to the engine will not be permitted.

B.) 4777 and 80777 Option:

- 1.) The carburetor must maintain the stock venturi and throttle bore dimensions.
- 2.) The carburetor must maintain all stock dimensions, including mounting and stud location on intake manifold.
- 3.) The booster height must remain stock OEM from Holley. Cutting, tumbling and/or polishing will not be permitted.
- 4.) Visible modifications will not be permitted.
- 5.) The maximum height of the carburetor when measured from the bottom of the carburetor and/or the throttle plate to the machined horizontal surface of block will be in 7"-inches in both the front and rear of the block.
- 6.) The following alterations will be permitted;
 - a.) Holes drilled in the throttle plate for proper idle.
 - b.) Drilling, tapping and plugging of unused vacuum ports.
 - c.) Welding of throttle shaft to linkage arm.
 - d.) Drilling of idle and/or high speed air correction jets.
 - e.) Milling of center carburetor body metering block surface, maximum of .015" on each side.
 - f.) Removal of choke plate and shaft.
 - g.) The jets may be changed as needed.
- 7.) Gauge measurements (go/no-go) must be met at all times, regardless of carburetor temperature.

C.) HP 80541-1 Option:

- 1.) The carburetor must remain stock retaining all Holley measurements and dimensions. The carburetor may be adjusted utilizing only specified Holley replacement parts.
- 2.) Jets, bleeds, needle and seat, emulsion bleeds, power valves, accelerator pumps nozzles and accelerator pump cam adjustments will be permitted.
- 3.) Physical alteration of carburetor components and/or parts and/or any alterations, machining and/or reshaping will not be permitted. The use of epoxy and/or coatings of any kind will not be permitted.

D.) Holley 26-342 float bowl vent tube check valves are highly recommended, and will be mandated effective January 1, 2020.

E.) A single unaltered carburetor spacer plate with an unaltered square hole/opening including gasket with a maximum thickness of 1-1/8"-inch will be permitted. Tapering, machining and/or any other alteration to the spacer plate will not be permitted. Spacer may not protrude down into intake manifold..

F.) Pipe plugs must remain in manifold heat crossover port.

G.) The only permitted air filter top and base will be part # PAC-14804 RUSH, which are available through Pace Performance. Ram air, air box and/or heat shield type devices will not be permitted. The air cleaner must remain in place when the hood is removed. A flat piece of metal "may" be added and securely fastened to AND LEVEL WITH the hood following the contour of the hood scoop to act as a dust shield. The metal attachment can follow the contour of the air cleaner but is not to go past the centerline of the carburetor. The rear 180 degrees of the bottom of the hood scoop must remain open and not enclosed. The opening behind the air cleaner must extend parallel to the air cleaner, to the ear of the hood enclosure/firewall. There cannot be any metal attachment to the air cleaner. Air cleaner must be centered on the carburetor.

H.) Air induction plastic carburetor insert and/or other devices that direct air into the air intake will not be permitted.

I.) Air diffusers will not be permitted.

J.) A minimum of two (2) throttle return springs and a metal toe loop (2) mounted on the gas pedal will be required. The throttle return springs must be mounted in separate locations.

K.) Only one mechanical fuel pump in the stock location will be permitted. Fuel must be delivered through the fuel system from the fuel cell to the mechanical fuel pump. Return line, pressure regulator of any type and/or other volume and/or pressure altering devices will not be permitted.

Ignition

A.) Only stock OEM distributors will be permitted. Alterations and/or adjustments will not be permitted to distributor with the exception of the distributor advance curve may be locked. All other parts must remain stock.

B.) The car must be fitted with only one (1) unaltered approved MSD RPM (rev) limiting box, part number 8727CT. The black wire must be grounded to the motor. Rev limiter box MUST be set as 6,000 RPM. The box must remain operable and working condition, prior to, during and after all racing events. The rev box must be in clear view without removing the hood.

PENALTIES: If rev limiter box is found to be not set at specified RPM of 6,000, driver and car will be disqualified for the night's events and both driver and car owner will be suspended for the next completed RUSH Sportsman Modified event.

D.) Trigger-type and/or crank trigger-type ignitions will not be permitted.

- E.) The ignition must be mechanically driven in the stock OEM location.
- F.) Only the stock OEM H.E.I. ignition coil will be permitted.
- G.) The wiring must remain as specified by the ignition amplifier box manufacturer.

PENALTIES: If wiring is found not to be installed properly per amplifier box manufacturer's specific instructions, driver and car will be disqualified for the night's events and both driver and car owner will be suspended for the next completed RUSH Sportsman Modified event.

- H.) One American Passenger Car sized battery with terminals on top or side and a maximum of 12 volts will be permitted. The battery voltage must not measure more than 14.3 volts. Step up transformer and/or any other device designed to increase voltage will not be permitted.
- I.) The battery must be securely mounted inside the frame rails.
- J.) OEM stock firing order must be maintained for all engines. Standard GM Firing Order 18436572.
- K.) Ignition amplifier boxes, "rev boxes", RPM limiting chips, may be inspected, confiscated and/or exchanged by RUSH Officials at any time. Failure to relinquish electronic ignition will result in disqualification (loss of points and monies) and "refusal of tech" penalties.
- L.) Traction control devices will not be permitted. Braking devices that control traction will not be permitted.

Lubrication/Oiling System/Oil Cooler

- A.) Only a single wet sump oil pump will be permitted. Dry sump oil systems will not be permitted.
- B.) Only magnetic steel oil pans will be permitted.
- C.) External type oil pumps and/or vacuum pumps will not be permitted.
- D.) Accu Sumps will not be permitted.
- E.) Engine evacuation systems by internal and/or external driven pumps or by connection between exhaust system and/or valve covers, intake manifold and/or oil pan will not be permitted.
- F.) Oil coolers will be permitted.

Transmission/Driveline and Driveline Components

- A.) Only approved North American and/or Canadian manufactured manual shift transmissions will be permitted. Automatic and/or automatic-type transmissions will not be permitted.
- B.) Overdrive and/or under-drive transmissions will not be permitted.
- C.) Running through reduction gears will not be permitted. The transmission must be direct drive to the rear end.
- D.) The transmission must have working gears. Forward, neutral and reverse must be working. From the neutral position and with the motor running, the car must be able to go forward and/or backward in a smooth manner. The car must start and move under its own power.
- E.) The transmission must bolt to the bell housing.
- F.) Driveline components made of carbon fiber, titanium and/or other materials (considered exotic) will not be permitted.
- G.) A maximum of two (2) universal joints per driveline will be permitted.

Driveshaft

- A.) Only one (1) drive shaft connected from the transmission to the center section of the rear end will be permitted. Only magnetic steel drive shafts will be permitted. Titanium and/or aluminum drive shafts and/or drive shaft yokes and/or driveline components will not be permitted.
- B.) Two (2) driveshaft hoops/rings a minimum 1/4"-inch thick x 2"-inch wide magnetic steel must be positively fastened by two (2) 3/8"-inch grade 5 bolts to the frame and/or torque arm side plates installed around each universal joint.
- C.) The drive shaft must have some type of drive shaft cover/shield. Cars with open drive shafts must have a drive shaft tunnel a minimum of 1/8"-inch thick by 6" wide magnetic steel extending from 2"-inches under the front edge of the seat and up the back of the seat 4" covering the transmission, driveshaft and the universal joint(s) and output flange on top and both sides. The tunnel must extend down to the floorboards. The cover must be positively fastened with a minimum of four (4) 3/8"-inch diameter bolts at the bottom connected to a cross-member. The cover must be a solid unit with no cuts and/or holes and/or removed material for the purpose of weight reduction. The only hole may be for the gear shift control.
- D.) Closed drive type cars, torque tubes and/or bells that already have a 360-degree cover from the universal joint back to the seat will be permitted.

E.) Carbon fiber, titanium, and/or other materials (considered exotic) will not be permitted.

Engine Cooling System/Radiator

A.) Only cast iron water pumps will be permitted.

B.) Only one (1) radiator will be permitted. The minimum width of the radiator will be 20"-inches when measured from the outside edge(s) of the radiator. The radiator must be mounted vertically in front of the engine. The minimum height of the radiator must be 22"-inches when measured from the bottom of the frame rail vertically and may incorporate the oil cooler to achieve the vertical height. Radiators mounted on an angle will not be permitted.

C.) Plastic and/or carbon fiber radiators will not be permitted.

D.) Auxiliary cooling tanks and/or overflow cans and/or canisters will not be permitted in the cockpit.

E.) The cooling fan for the radiator must be mounted in the stock OEM location on the front of the water pump. Fan mounted to the crankshaft will not be permitted. Fan must be steel, aluminum or plastic. No electric fan and/or pumps permitted.

F.) A 2"-inch maximum air deflector in front of the radiator for engine cooling will be permitted.

Rear End

A.) Only Quick Change type rear ends will be permitted.

B.) Hypoid-type and/or Nine (9") Ford-type and/or limited slip-type and/or lockers and/or two speed rear ends will not be permitted. Non Quick Change Rear Ends not permitted

C.) Only aluminum and/or magnetic steel spools will be permitted.

D.) Only steel and/or aluminum rear spindles will be permitted. If the rear spindle is machined from aluminum it must be a one-piece tube and spindle with a minimum outside diameter 2-7/8" and a maximum 2-1/2" inside diameter.

E.) Live rear ends with aluminum tubes will be permitted. All others must be approved.

F.) Carbon fiber, titanium and/or other materials (considered exotic) for any rear end component will not be permitted. Tungsten or any other exotic metal are not permitted, in any form.

G.) A maximum rear end offset of 4"-inches from the center of the inside tire width when measured from the inside of the left rear tire to the inside of the right rear tire at axle height. Refer to the drawing at the back of this rule book.

H.) Aluminum rear end tubes only, with a maximum wall thickness of .410". Outer diameter cannot exceed 3".

I.) Outer collars (other than to attach bridge cage) are not permitted. Excessively thick or enlarged brackets are not permitted. All brackets must be aluminum.

J.) Drive Axles must not exceed 1.600" diameter and must be made of steel only. No tungsten. Inserts to be slid inside of tubes, made of any material, are not permitted.

K.) Ballast inside, attached to, or machined into hubs are not permitted. Maximum hub weight 10 lbs

Fuel, Fuel Cells and Fuel System

A.) All cars must have fuel cells that meet and/or exceed SFI 28.1/.2 and/or FT3 specifications and must be not be older than five (5) years from the date of manufacture. The fuel cell must not exceed a 24.5-gallon capacity and must remain in a rectangle and/or square shape for measuring and calculating capacity. The fuel cell must be mounted securely in its container and centered between the frame rails. Pressure tanks on fuel systems will not be permitted. Auxiliary fuel tanks will not be permitted.

B.) The foam in the fuel cell must remain unaltered. A minimal cut in the foam will be permitted in the shape of a square or a rectangle. The cut may be no more than 1,000 square inches. The foam must retain the factory cut.

C.) The fuel cell must be enclosed completely in a rectangle and/or square container that is a minimum thickness of 20-gauge magnetic steel. An aluminum container may be used as an option and must be a minimum of .060"-inch in thickness. On the bottom of the fuel cell, a piece of .090-gauge material (aluminum and/or magnetic steel – in addition to the existing container) must be used at the bottom of the fuel cell container to prevent bowing and/or deflection. The .090-gauge material must have an inspection hole drilled near the center of the piece to measure the thickness of the material. A 1"-inch x 1"-inch x .0625"-inch thick magnetic steel square tubing rack must be fabricated on the top, front and rear sides of the fuel cell container. The square tubing must be a minimum of 5"-inches from the outside edge of the fuel cell on either side. The rack may be fastened to the bottom of the fuel cell can utilizing a piece of magnetic steel angle material that is a minimum of 1"-inch x 1"-inch with a minimum material thickness of

.065"-inch magnetic angle steel that is on all four (4) sides of the container. Drilling multiple holes and/or any attempt to lighten any piece within the fuel cell container and/or rack will not be permitted. The measurements taken in regard to the fuel cell container will be measured on an inside-to-inside basis. A tolerance for material thickness will be calculated and permitted for dimensions, however there will be no tolerance for expansion and/or containers that are larger than the minimum.

D.) For the purpose of inspection, the driver and/or crew must be prepared to drain fuel upon request for inspection and/or measurement.

E.) Fuel coolers of any type will not be permitted.

F.) No dry ice or any other cooling agents will be allowed on the motor during competition.

G.) Only RUSH '91' pump fuel will be permitted for competition in RUSH Racing Series sanctioned events. Additives and/or blending of any type including; methanol, alcohol, nitrous oxide, propylene oxide, nitromethane or other performance enhancing chemical additives will not be permitted. Fuel may be tested from time-to-time and/or submitted for verification by designated RUSH Racing Series and/or Track Officials to Sunoco Race Fuels. **It is the racer's responsibility to know what he or she is putting in the fuel cell.**

H.) Series reserves the right to check fuel anytime. Three samples will be taken by RUSH or Track Official. Each sample will be identified as sample #1, sample #2, and sample #3. Sample #1 will be retained by Series and sent to lab; sample #2 will be given to selected fuel's driver/owner; and sample #3 will be retained by Series to be utilized as a tie-breaker in the event any issues may occur with samples #1 & #2. In the event driver/owner chooses to send sample #2 to be analyzed, RUSH must approve selected lab. Fuel samples not conforming to RUSH Sportsman Modified Series Fuel rule will be deemed illegal.

I.) Series Officials may amend the fuel rule for any event, and will inform competitors.

J.) **PENALTIES FOR FUEL VIOLATIONS:** Disqualification from event (loss of points and money) in addition to the following penalties:

- First Offense: \$500 fine & 30-day suspension from any RUSH-sanctioned event plus all related lab testing costs.
- Second Offense: \$1,000 fine & 90-day suspension from any RUSH-sanctioned event plus all related lab testing costs.
- Third Offense: \$2,000 fine & 365-day suspension from any RUSH-sanctioned event plus all related lab testing costs.

Exhaust and Sound Reduction Devices

A.) Each car must have one (1) unaltered muffler per exhaust.

B.) The exhaust must exit past the driver and the exhaust must flow toward the rear of the car in an upward manner away from the racing surface. Exhaust systems that face the outside of the car will not be permitted.

C.) Each muffler must have a tail pipe that is a minimum of 10"-inches long when measured off the rear edge of the muffler.

D.) Cross-over and/or the joining of exhaust systems from side-to-side will not be permitted.

E.) Only Schoenfeld headers, model numbers: 1122B, 1122BCM, 1122BUCM2 or 1122BCM2 will be permitted. The exhaust headers must not exceed 1-5/8" in outside diameter. Tri-Y, step headers, stainless steel, coated, ceramic and/or otherwise, and/or merge collectors will not be permitted. The Schoenfeld header must be clearly labeled by the manufacturer for ease of inspection. (Correct label - Dirt 2005)

F.) The only permitted muffler is the Schoenfeld #112530. Mufflers must be labeled clearly by the manufacturer.

G.) The header collector extension pipe and tail pipe must be inserted past the muffler inlet or outlet flange and must exit behind the driver. *Any other extensions and or add on components will not be permitted.*

H.) All Schoenfeld headers must be able to be separated from the rest of the exhaust system for the purpose of inspection.

I.) The complete exhaust system must be sealed. Any type of add on, return system and/or exhaust evacuation system will not be permitted.

TRACTION CONTROL/RADIO/TRANSMISSION DEVICES:

A. All Traction Control Devices are strictly prohibited during any form or portion of a RUSH Series sanctioned event, race or practice/test session.

B. All traction control devices, whether electronically controlled in the ignition system, wheel sensors or any means of measuring ground speed to control wheel spin, are strictly prohibited. All devices not mentioned in the above that are found to control wheel spin, timing or fuel delivery control will be considered strictly prohibited.

- C. At NO time will there be any type of ping control devices, remote devices that modify RPM and/or timing, automated throttle controls, timing controls, or any modifications to the ignition control boxes, distributors, or any other part of the Ignition System. This includes any add on component or components inside or outside the cockpit of any competitor's race car. There shall be NO driver controlled wheel spin, timing or fuel delivery control devices in the cockpit area of any race car. Remote control components utilized to affect and/or control wheel spin, timing or fuel will not be permitted.
- D. Adjustable restrictor plates will not be permitted.
- E. Radios and/or devices transmitting voice and/or data will not be permitted.
- F. Data acquisition systems will not be permitted.
- G. A competitor found with any of the devices mentioned under Traction Control/Radio/Transmission Devices, #1-6, will be disqualified from the event (loss of points and monies), forfeit the device permanently and the following:
 - First Offense: \$500 fine & 30-day suspension from any RUSH-sanctioned event plus any testing costs, if required
 - Second Offense: \$1,000 fine & 90-day suspension from any RUSH-sanctioned event plus any testing costs, if required
 - Third Offense: \$2,000 fine & 365-day suspension from any RUSH-sanctioned event plus any testing costs, if required
- H. A competitor refusing to relinquish any of the above mentioned will result in disqualification from the event (loss of points and monies) and "refusal of tech" penalties.
- I. GPS and/or any other type of electronic tracking and/or locating device will not be permitted for any reason. If found, driver and car will be disqualified for the night (loss of points and monies), and will forfeit device permanently.
- J. GoPro and/or similar camera devices are permitted providing they do not interface with the car, electronic or otherwise, and do not transmit any signals. Cameras not meeting specifications, will result in driver and car being disqualified for the night (loss of points and monies), and will forfeit device permanently.
- K. No cameras and/or video recorders and/or photographic recording equipment may be mounted below the deck. If found, driver and car will be disqualified for the night (loss of points and monies), and will forfeit device permanently.

Chassis/Frame

- A.) The minimum wheel base is 106"-inches and a maximum of 110"-inches with a maximum tolerance of ½", when measured from the centerline of the rear axle to the centerline of the front axle for both left and right sides.
- B.) All frames must be fabricated utilizing 2"x4" rectangular magnetic steel tubing with a .120" wall thickness. Only 2"x4" rectangular box frames between the front and rear axle centers will be permitted. The 4"-inch side of the rectangular tubing must remain in the vertical position. For the purpose of inspection one 3/16" diameter hole may be drilled in each frame rail. Other holes will not be permitted. Round tubing must be either 1-1/2" outside diameter and/or 1-3/4" outside diameter with wall thickness of .095"-inches.
- C.) Frame width will be as follows; At the front shock towers a minimum 24" and a maximum of 35"-inches. Rear of the car is a minimum of 26" with a maximum of 35"-inches. The minimum frame width at the rear roll bar must be 26"-inches. All measurements will be taken from the outside of the frame rails, at the top and bottom of the frame rails and its longest length. Clips, sub-frames, etc., will be considered a part of the frame.
- D.) The minimum length of the 2"x4" frame rails begins 14"-inches in front of the centerline of the rear axle and extends to the front of the radiator. The left and right rails (both top and bottom) must be equal in distance from the driveline centerline along the total length of the frame. Offset frame rails will not be permitted. A maximum 4"-inch indent in the lower left rear frame rail for suspension clearance will be permitted. The two (2) upper frame rails in the engine compartment may be altered for engine clearance only.
- E.) The kick-ups must meet the same specifications as the roll cage and/or frame material.
- F.) Titanium and/or carbon fiber material(s) will not be permitted on the chassis and/or frame.
- H.) There must be a minimum of 2-1/2"-inches ground clearance from the chassis at its lowest point.
- I.) Ground effects will not be permitted.

Seat Location and Mounting in Frame

- A.) The seat and steering wheel must be centered in the frame. Offset mounting of the seat and/or steering wheel will not be permitted.
- B.) The bottom rear of the seat must be a maximum of 16"-inches from the centerline of the rear axle. Refer to the drawing at the back of this rule book.

Roll Cage

- A.) Only round magnetic steel tubing 1-1/2" and/or 1-3/4" in outside diameter with a material thickness of 1-3/4"-.095"-inches and/or 1-1/2"-.120"-inches will be permitted.
- B.) The roll cage must be an integral and structural part of the frame. All frames built in 2005 and after must have a manufacturer's unique serial number plate visible and positively fastened on the left front roll cage upright. The letters and/or numbers shall not exceed 8 digits and be 1/2"-inch in height. See drawing 4.7.2
- C.) Front and rear roll bars must be positively fastened in a cage-type configuration. Two (2) round horizontal side bars on each side are required. The top side bar must be a maximum of 22"-inches below the top roll bar.
- D.) Proper bracing and triangulation on the front and rear roll bars is required. All roll bar bracing material must be 1-1/2"-inches outside diameter with a material wall thickness of .095"-inches. A minimum of one (1) diagonal bar across the top of the roll cage is required.
- E.) The rear main roll bar hoop must be a minimum of 26"-inches when measured across the outside-to-outside of the hoop and maintain that measurement from the top to the bottom of the cage. The bottom of the rear main roll bar hoop must be positively fastened (welded) to the 2"x4" frame rails. Outriggers will not be permitted.
- F.) The front roll bar hoop must be a minimum of 26"-inches when measured across the outside-to-outside of the hoop and maintain that measurement from the top to the bottom of the cage, with the exception of the allowable frame taper. Outriggers will not be permitted. Refer to the drawing in the back of this rule book.
- G.) MANDATORY Frame/Roll Cage: A piece of tubing, a minimum of 1-1/4" in outside diameter and .095"-inches in thickness, must be installed vertically and must extend through the car into the bottom frame rail or extend back to the union at the top of the door and rear main hoop joint. The tubing must be installed in a manner that does not impede the driver exiting the cockpit. The tubing must be mounted a minimum of 9"-inches and a maximum of 12"-inches on the roof bar from the existing rear roll cage hoop. This must be installed symmetrically on both sides of the roll cage. Existing cars must be retrofitted with this piece of tubing.

Weight / Ballast

- A.) All cars must weigh a minimum of 2,450 lbs. with driver after the event. The track scales will be considered the official scales for the event. Any car that is light at the scales following a heat race, B main/consy, or feature will be disqualified from the event. The track scales will be considered the official scales for the event.
- B.) Ballast and/or weight may not be mounted to the roll cage above the rear deck.
- C.) All added weight(s) must be securely attached to the frame below the body decking.
- D.) Frame is defined as the steel welded structure only.
- E.) Any part that moves or is not a fixed component to the steel frame structure may not be used for any weight attachment.
- F.) No weights may be attached to the rear bumper or outside the frame.
- G.) All weight(s) must have a minimum of two (2) 1/2"-inch diameter. grade 5 bolts and/or studs passing completely through the weight. Bolts and/or studs must be anchored to a suitable clamp to fasten it to the frame. Bolts and/or studs welded to the frame will not be permitted. Penalty for losing weight on race track is disqualification from the event they are competing in.
- H.) Weight must be painted white with car number displayed. Penalty for losing attached weight on the race track is disqualification from the event competing in.

Body

ALL MEASUREMENTS WILL BE TAKEN WITH DRIVER AND/ OR WITH OR WITH OUT FUEL. TOLERANCE PERMITTED ON ALL BODY DIMENSIONS IS MAXIMUM OF +/- (PLUS OR MINUS) 1/2"-INCH (ONE-HALF INCH). THIS IS A TOLERANCE, NOT A DIMENSION THAT IS INTENDED TO BE ADDED TO THE BODY DIMENSIONS.

General Body

- A.) Mirrors and/or reflective devices will not be permitted.
- B.) RUSH Series Officials reserve the right to request body and/or sheet metal to be replaced and/or painted if it has any sharp edges and/or does not appear presentable. Presentable is at the discretion of the Series Official.
- C.) The maximum rear spoiler height, regardless of ride height, may not exceed 50"-inches. The rear spoiler must be able to provide the driver following a view of the track ahead.
- D.) A full magnetic steel windscreen and/or rock guard is required. The windscreen and/or rock guard must have an individual hope opening of 2" x 1" with a minimum of 1/16" thickness. Chicken wire type and/or aluminum screens will not be permitted. The windscreen and/or rock guard must cover the entire windshield area across the front of the roll cage and from the top of the roll cage down to the base of the cowl and/or hood. In addition clear lexan-type and/or safety glass windshields will be permitted. If the

lexan and/or safety glass is utilized it must be shatterproof and mounted behind the windshield and/or rock guard. Any additional windshield must not obstruct the driver's exit of the vehicle.

E.) The minimum size opening for the side windows will be 12"-inches in height by 18"-inches in width by 30"-inches in depth. A rectangular box, matching these dimensions may be used to pass through the car from one side window through to the other.

Body Material

A.) Only magnetic steel and/or aluminum will be permitted for all inner and outer body panels.

B.) Vertical material (plastic and/or rubber-type), with a material thickness between .090"-to-.125"-inch and a minimum height of 8"-inches from the bottom of the quarter panel will be permitted, provided both doors and/or quarter panels maintain the same length and height with or without the plastic (symmetrical). An overlap of two (2") inches to secure the door(s) extensions will be permitted. The door(s) must maintain a minimum of six (6") inches of ground clearance including the additional material extending below the metal body. The overall dimensions of the door(s) and extensions must meet the specifications.

C.) Only a single piece fiberglass roof will be permitted.

D.) Only fiberglass and/or aluminum hood, hood scoop, windshield cowl, rear interior tire clearance cover will be permitted.

E.) Only clear lexan will be permitted for the rear spoiler and rear wing windows. Decals and/or lettering will not be permitted on the rear spoiler and/or rear wing windows.

Roof

A.) A one-piece fiberglass roof, single ply, one contour inside and out will be permitted. Carbon fiber and/or any other composite type materials will not be permitted. All roll bars must remain exposed. Vertical material of any type used to mount the roof that may cover the roll bar will not be permitted. The roof must weigh a minimum of 10 lbs.

B.) The roof must be centered from side-to-side on the roll cage and on the frame. Offset bodies will not be permitted. The leading edge of the roof must be positively fastened in a stationary position a minimum of 33"-inches and a maximum of 48"-inches in front of the rear axle centerline. The roof must be securely and positively fastened on all sides.

C.) The minimum length of the roof is 48"-inches with a maximum of 60"-inches. The minimum width of the roof is 48"-inches with a maximum of 52"-inches. The roof must be of the turtleback style and shape with a minimum of 3/4"-inches belly from front-to-rear and 3/4"-inch from side-to-side. The roof -contour must fit the RUSH roof template patterns. Flat roofs will not be permitted. The maximum front lip must be 1/2"-inch. The maximum side edge(s) must be 1-1/8"-inch break. Refer to drawing (NUMBER) on page (NUMBER).

D.) Changes to the shape and/or location of the roof at any time during competition will not be permitted.

E.) The maximum overall height of the car is 62"-inches with a minimum of 53"-inches measured from the ground.

F.) The maximum roof angle is 5 degrees when measured with the RUSH gauge. (See reference drawing).

G.) Any proposed roof design that deviates from the preceding rules must be submitted to RUSH for approval and approved before being presented for competition.

Front Door Posts

A.) Only a one (1) piece magnetic steel and/or aluminum front door posts and/or 'A'-pillars a minimum of .050"-inches with a maximum of .090"-inches will be permitted. The front door posts must be securely mounted the roof and to the door(s). The side of the front door post must measure a maximum of 2"-inches. The front door post may be bead rolled and/or have a lip and/or flange for re-enforcement, but the re-enforcement must not exceed a maximum 3/8"-inch., in width.

B.) The door post may be fastened with a minimum of two (2) 3/16"-inch bolts to the door bracket for ease of fabrication.

C.) Additional material, air directional devices, lexan vent windows and/or excessive material will not be permitted in the corner of the front door post, where the post meets the door panel. Any additional material, air directional devices and/or vent windows must be a maximum of 10"-inches in length.

D.) There will be no tolerance on the front door post measurements.

Rear Wing Windows / Side View / Rear View

A.) All rear wing panels and windows must resemble a current production OEM style body. Only manufacture approved rear wing panels and windows will be permitted for competition. Any non-manufacture rear wing panel must resemble and/or meet the criteria as the submitted rear wing panels and/or windows. Any rear wing panel that is submitted for competition must not exceed 815 square-inches in total area. **All rear wing panels must be submitted for approval prior to introduction into competition.**

B.) The upper profile must not extend above a straight line projected from the rear of the roof to a point 3"-inches higher than the rear deck. A minimum 2"-inch indent in the profile, so as not to make the panel a fast back is mandatory. (Please refer to the drawing and photographs)

C.) The maximum base length will be 61"-inches. The left and right must be of the same style and dimensions (symmetrical). (See example of Body Style Drawing)

D.) All rear wing(s) must have an opera-type window. The window may be lexan, or a decal that resembles an opera-type window can be utilized. No lettering will be permitted on the rear wing panel. Bends or breaks in the lexan or decal area of the window will not be permitted.

E.) Only one break as a change in body line/contour will be permitted in the rear wing panel.

F.) The rear view of the wing window must go in a straight line from the top of the quarter panel (tangent) or bodyline to the roof with a maximum gradual bow of 2"-inches in the center of the wing window.

G.) Flanges and or additional material added to the rear wing panel for the purpose of directing air flow will not be permitted.

Body Width and Ground Clearance

A.) The body width, when measured at any point along the body line from front-to-back will be a maximum of 68"-inches and a minimum of 64"-inches.

B.) A minimum chassis ground clearance of 2 ½"-inches will be permitted.

C.) Fan and/or ground-effect cars will not be permitted.

D.) Rubber skirts, fins, air directional devices and/or spoilers of any type under the car will not be permitted.

E.) A 2"-inch maximum air deflector in front of the radiator for engine cooling will be permitted.

Door Panels

A.) The side door panel(s) will be a maximum of 85" inches and a minimum of 60"-inches in front of the centerline of the rear axle. The door(s), front door extensions and rear quarter panels must be flat and mounted in a vertical position. They must remain flat. Flanges at a 90 degree angle may be added to the front of the doors. The flange may only be added for the purpose of strengthening the door material. The flange must not exceed ¾"-inch in length or width and must be mounted in a vertical position. Door flanges must face inward toward the centerline of the chassis. Louvers, bead rolls holes and/or protrusions from top-to-bottom will not be permitted. Holes will be permitted for rub rails/nerf bars. A maximum 1"-inch long lip/flange at a 45 degree outward angle ½"-inch away from the sheet metal for reinforcement will be permitted at the top and bottom of the door(s) panels. All outside sheet metal, door panels, door extensions, air dams, front nose and/or hood fins must be the same shape, size and angle on both sides of the car. The door(s) must match each other from side-to-side (symmetrical). Air directional devices and/or side mounted spoilers of any type, which extend past the outside edge of the flat plane of the body will not be permitted.

B.) Bead rolls around the outside perimeter of the door panels and the wing windows will be allowed. Bead rolled edges must face toward the center of the chassis.

C.) The front door(s) extensions will be a maximum of 20"-inches behind the front axle centerline.

D.) The top front corner of the door when measured from the ground will be a maximum of 38" and a minimum of 30"-inches when measured 60"-inches from the rear axle centerline. The rear of the door when measured from the ground will be a maximum of 42"-inches to the top of the door when measured 16"-inches from the center of the rear axle centerline of the rear forward.

E.) The ground clearance on the bottom of the doors must maintain a maximum of 12"-inches and a minimum of 6"-inches from the ground.

F.) A maximum lip and/or flange of 1-1/2"-inches rounded at 90 degrees and facing inward only, on the top and bottom door(s) and rear quarter panel(s) will be permitted.

G.) A lip and/or flange angled out at a maximum angle of 45 degrees, extending away from the door at a maximum of ½"-inch and a maximum of 1"-inch in length before it bends inward for strength at the top of the door(s) and/or rear quarter panel(s) will be permitted.

Rear Quarter Panels

A.) The rear quarter panels must be symmetrical in height, with or without plastic.

B.) The rear quarter panels must be a maximum of 47"-inches and a minimum of 40"-inches from the ground at the rear and continue in a straight line with the top of the door. (See drawing.).

C.) A maximum 2"-inch fender flare may be used, but the overall body width must maintain a maximum of 68"-inches.

D.) The rear quarter panels may extend rearward a maximum of 48"-inches at the top and a minimum of 44"-inches at the bottom when measured from the center of the rear axle to the rear of the car.

E.) A maximum of 16"-inches and a minimum of 8"-inches of ground clearance (when measured from the ground to the bottom of the rear quarter) will be permitted.

F.) The plastic / rubber material utilized on the rear of the car may extend a maximum of 16"-inches from the ground to a minimum of 8"-inches from the ground on either side of the car (symmetrical). The panels may have one side plastic on one (1) side only provided the panel remains completely symmetrical.

G.) Flanges at a 90 degree angle may be added to the Rear Quarter Panels. The flange may only be added for the purpose of strengthening the Rear Quarter Panel. The flange must not exceed ¾"-inch in length or width and must be mounted in a vertical position. Rear Quarter Panel flanges must face inward toward the centerline of the chassis. Air directional devices and/or side mounted spoilers of any type, which extend past the outside edge of the flat plane of the body will not be permitted.

Rear Spoiler

A.) A one piece, clear lexan spoiler with a maximum height of 5"-inches from the rear deck will be permitted. Lettering and/or decals will not be permitted.

B.) The rear spoiler must be non-adjustable from the cockpit and/or during racing conditions. Hinges, adjuster(s), slides and/or any other adjusting type device will not be permitted.

C.) Metal gurney and/or table and/or flanges and/or lips will not be permitted.

D.) A brake and/or bend on the top of the Lexan spoiler will be permitted for reinforcement.

E.) The maximum overall height of the spoiler when measured from the ground must not exceed 50"-inches.

F.) A maximum four (4) of vertical supports (a maximum of 2"-inches in vertical height and 10"-inches in length) for the purpose of fastening the spoiler to the rear deck will be permitted.

Rear Deck

A.) The maximum height the rear deck when measured from the ground will be 47"-inches and a minimum of 40"-inches.

B.) The rear deck lid must be fully enclosed from side-to-side and have a maximum height of 14"-inches and a minimum 9"-inches, vertically behind the fuel tank.

C.) The left and right rear trunk lids must be symmetrical in size and shape and must remain flat to cover the fuel filler hose and apparatus. The panel must completely cover the fuel cell, the fuel filler hoses and the vent lines.

D.) The fuel tank must be completely enclosed from the bottom of this panel to the bottom of the fuel cell.

E.) The fuel cell must have both sides completely covered in sheet metal in addition the container it is enclosed in. Openings of any type will not be permitted.

F.) Openings from the top of the fuel cell to the bottom of the trunk lid will not be permitted.

G.) All vent line nozzles used for the purpose of a catch can must be mounted on the left side of the quarter panel.

Hood, Nose and Front Spoiler

A.) The maximum width for the hood, nose and front spoiler will be 36"-inches with a minimum width of 24"-inches. Louvers will be permitted on the sides and top of the hood for cooling purposes only.

B.) The nose-piece must not extend rearward of the front shock towers.

C.) The front spoiler must be a separate piece.

D.) Shock absorber covers and/or deflectors must not be a part of the nose or the spoiler and/or positively fastened to the nose in any fashion exceeding the 36"-inch maximum width.

E.) Fabric material shock absorber covers will be permitted. The covers must not be used to achieve any aerodynamic advantage and/or to deflect air in a positive manner.

F.) The maximum the spoiler may extend in front of the front axle centerline will be 20"-inches.

G.) The front spoiler must be non-adjustable (hinges and/or sliders will not be permitted).

H.) The hood shall be considered from the front roll cage to on top and in-line with the front of the radiator.

I.) The hood and nose may have a maximum lip and/or flange of 2"-inches on both side following the contour of the body. They must remain symmetrical.

J.) The hood and nose be centered on the centerline of the frame.

K.) The hood, nose and/or spoiler must not overlap each other's location on the frame.

L.) Any part of the hood must not exceed 10 degrees and the sheet metal must not have an opening and/or extrusion between the hood and the nose.

M.) The hood must extend over the radiator and have complete sides.

N.) The front spoiler may have a lip and/or flange a maximum 2"-inches on both sides following the contour of the spoiler not exceeding the maximum width of 36"-inches. The front spoiler may be offset 1"-inch from the centerline of the frame to the right or the left. One 2" high wicker bill may be added horizontally to spoiler in front of shock towers.

Hood Scoop

- A.) The hood must be fully enclosed.
- B.) There are two (2) of hood scoops that can be mounted on top of the hood for the purpose of enclosing the carburetor and/or ram air. Ram Air will be permitted providing they meet the following specifications in this section.
- C.) The ram air scoop: A maximum 30"-inch length when measured from the rear motor plate to the front of the hood scoop will be permitted. A maximum width of 18"-inches will be permitted. The maximum 6"-inch front vertical opening at the beginning of the scoop will be permitted. A minimum of 8"-inches will be required from the highest point on the hood scoop to the lowest point on the front of the front of the roll cage and/or the roof. The hood scoop must be positively fastened to the hood and completely enclose the carburetor and the air filter.
- D.) The conventional air scoop (non-ram air): A maximum of 25"-inches is permitted from the center of the carburetor forward to the end of the hood scoop. A maximum width of 22"-inches will be permitted. A minimum of 8"-inches will be required from the highest point on the hood scoop to the lowest point on the front of the front of the roll cage and/or the roof. The hood scoop must be positively fastened to the hood and completely enclose the carburetor and the air filter.

Interior Sheet Metal

- A.) All horizontal body support(s) other than the inner pods, whether in the front and/or rear must be a minimum of 1" x 1" .095"-inch thick tubing or 1"-inch flat stock a minimum of .125"-inch thick.
- B.) Inside and/or outside wings, spoilers, air foils and/or wind deflectors will not be permitted.
- C.) Double panels and/or sheet metal that is designed to create a wing effect will not be permitted.
- D.) A maximum 1"-inch reinforced flange will be permitted on all lexan, however, all specified measurements must be retained.
- E.) All interior sheet metal must completely cover all interior areas, door-to-door, quarter panel-to-quarter panel. Holes and/or openings will not be permitted in this area.
- F.) Front and rear firewalls are required. The front firewall must isolate the cockpit from the engine compartment. The rear firewall must extend from the top of the fuel cell to the belly pan to isolate the cockpit from the fuel cell. The firewall must be a minimum of .050"-inch thick aluminum and/or magnetic steel. The firewall may be altered and/or cut for drive shaft clearance.
- G.) Vertical fins, air dams and/or fairings on either side, behind the roll cage will not be permitted.
- H.) All sheet metal must be a flat single plane across the interior of the car. Two (2) bead rolls or breaks for the purpose of strengthening and maintaining the shape of the wing will be permitted. The maximum bead roll and/or break permitted will be 1/8"-inch in height and 1/2"-inch in width.
- I.) Covered roll bars will not be permitted. Sheet metal that is one-piece and/or part of a body panel formed around tubing that is not considered an aerodynamic advantage will be permitted, provided there is no excess sheet metal.
- J.) Louvers will be permitted for cooling purposes only, including the radiator, engine and/or a working oil cooler. Louvers and/or holes in the interior or exterior sheet metal will not be permitted.
- K.) The floor and/or belly-pan may not be any wider than the frame at any point. Lips, fins and/or air directional devices on the floor and/or belly pan will not be permitted. The under pan must not extend in length past the rear of the seat and exceed the width of the frame rails of the car and must be a maximum of .090"-inches in material thickness.
- L.) Only aluminum belly pans will be permitted. Louvers for the purpose of cooling will be permitted on the belly pan from the radiator to the firewall. Panels under the rear and and/or the fuel tank will not be permitted.

Driver Compartment

- A.) A full metal firewall fabricated from magnetic steel and/or aluminum must encompass the driver's compartment from front-to-rear, on both sides and floor boards.
- B.) The driver's seat must be a high back aluminum seat, designed specifically for racing, located on the left side of the car and mounted per the manufacturer's instructions securely to the frame.
- C.) The seat design should be one from a current manufacturer and/or recommended to include the full containment design. Installation of the full containment seat should follow the manufacturer's instructions.
- D.) All cars must be equipped with a quick-release-type steering wheel that is a full circle.
- E.) The driver compartment must have a starting switch and/or button within reach of the driver.
- F.) A clearly labeled electrical on/off 'kill' switch must be within reach of the driver.
- G.) A clearly marked fuel shut off valve, labeled On and Off, must be mounted within reach of the driver. It must be labeled with the word(s) "Fuel Shut Off". Refer to the drawing in the drawing section of this rule book.
- H.) Mirrors of any-type will not be permitted.

- I.) Radios and/or electronic and/or data communication devices will not be permitted.
- J.) Any edge and/or sheet metal end in and around the driver compartment must be protected with trim and/or beading and rounded. Sharp and protruding edges will not be permitted.
- K.) A substantial rock guard with a minimum of three (3) additional roll bars must be mounted in front of the driver. The rock guard must be made from wire screen. Windshield screens must be a minimum of .090-inches and must be securely fastened.
- L.) Fuel and/or power steering lines and/or fittings running through the driver's compartment must be made from an approved braided type of line. High pressure lines and/or fittings and/or hot fluid lines running through the driver's compartment must be encased and/or must have a shield.
- M.) A fully charged fire extinguisher meeting SFI 167.1 specifications with an activation push and/or pull knob within reach of the driver is highly recommended.
- N.) Rear panhard bar adjustment devices will not be permitted in the driver compartment. Any rear panhard adjustments that has a knob and/or an adjustment device outside of the cockpit must be wired in a fixed position for competition. Adjustable panhard devices of any type will not be permitted during competition.
- O.) Only a single brake bias adjustment will be permitted in the cockpit.

Numbers and Identification

- A.) The track and/or series Scoring Director reserves the right to issue and/or change a car number to prevent duplication and/or maintain proper records.
- B.) Team cars must be clearly identifiable from one another and use another number and/or letter.
- C.) All number and letter combinations will be limited to three digits. If three digits are used two (2) shall be the primary numbers/letter.
- D.) Number and/or letter combinations are required on the roof, nose, rear deck and both doors.
- E.) All numbers and letters must be a minimum of 18"-inches high on the roof and/or doors and 8"-inches high for the rear deck and the nose. All numbers and/or letters must be equal in size and displayed legibly whether decal and/or painted.
- G.) The nerf bars must not block the visibility of the number and/or letter combinations.

Bumpers and Side Bars/Nerf Bars

General

- A.) All bumpers, side bars/nerf bars and/or bracing must be made from a minimum 1-1/2" diameter round ,095"-inch thick magnetic steel tubing only unless otherwise specified.
- B.) All edges and/or corners on bumpers and side bars/nerf bars must be rounded. Sharp edges will not be permitted.
- C.) The rear bumper and/or any side bars must not extend past the outside of the tire sidewalls on either the left and/or right side of the car.

Front Bumper

- A.) Only the front bumpers may be made from a minimum 1-1/4" diameter round ,095"-inch thick magnetic steel tubing.
- B.) The front bumper must consist of two (2) horizontal rails; an upper and a lower and a minimum of two (2) vertical braces, equally spaced, welded between the two (2) horizontal rails. The horizontal rails must be positively fastened to the frame with four (4) sockets and/or supports. The front bumper must remain exposed without covering and/or any sheet metal fabrication surrounding it.
- C.) The four (4) tubes that support the bumper from the four (4) frame sockets must be horizontal. These rails must be a minimum of 6"-inches and a maximum of 12"-inches apart when measured from the top to the bottom and maintain that measurement for a minimum width of 24"-inches and a maximum width of 30"-inches. The front bumper must also have an 18"-inch center when measured from the ground up to the middle of the bumper.
- D.) The maximum the front bumper may extend from the centerline of the front axle is 24"-inches and a minimum of 20"-inches.
- E.) The front surface of the bumper must remain flat, parallel and perpendicular with the front of the nose piece for the full width of the bumper. V-shaped and/or any other type of shaped bumpers will not be permitted.
- F.) The end bracing tube of the front bumper must be fabricated on an angle in such a way as to prevent the bumper of another car becoming interlocked. Please refer to the drawing at the back of this rule book.

Rear Bumper

- A.) The rear bumper must consist of two (2) rails, an upper and lower, which must have four (4) sockets and horizontal support bars positively attaching it to the frame. The upper and lower rails must also be a minimum of 10"-inches apart and a maximum of 16"-inches apart from the top to the bottom and maintain that measurement for a minimum width of the 64"-inches and a maximum of 86"-inches.
- B.) The rear bumper must have an 18"-inch center when measured from the ground to the middle of the bumper.
- C.) The maximum the rear bumper may extend back when measured from the centerline of the rear axle is 52"-inches.
- D.) The rear surface of the bumper must remain flat and parallel with the back of the rear quarter panel for the full width of the bumper. V-shaped and/or any other type of shaped bumpers will not be permitted.

Rub Rails

- A.) Solid and/or bars with ballast added will not be permitted.
- B.) The rub rails must be exposed and outside the body panels. The left side rub rail may extend a maximum of 2"-inches outside the left rear tire sidewall.
- C.) The rub rails must be bent with a gentle radius at a 90-degree angle and must protrude a minimum of 6"-inches back in past the body.
- D.) The rub rails must be a minimum of 50"-inches long from socket-to-socket.
- E.) Rub rails on the right side must only be a single bar piece of tubing from front-to-rear. Rub rails that have additional rails parallel to the main rail will not be permitted. Double rub rails will be allowed on left side only.

Bumpers and Rub Rails

- A.) Only a minimum of 5/16" bolts with nyloc nuts and/or RUSH approved quick release solid pins will be permitted for positively fastening bumpers and rub rails to the car. Cotter pins and/or other fastening devices will not be permitted.
- B.) All bumpers and rub rail sockets must have fasteners, pins and/or bolts with a minimum diameter of 5/16"-inch.
- C.) The front and rear rub rails must have a 360-degree sleeve a minimum of 3/8"-inch wide x .095" thick magnetic steel welded to the rub rail tube butted against the support socket to prevent pins from shearing. Refer to the drawing at the back of this rule book.

Suspension

- A.) Suspension designs and applications are constantly evolving. Although the intent of the suspension rules are an attempt to accommodate the majority of suspension and suspension component designs and applications currently being used in competition, the rules cannot be absolute. Any and all new designs or modifications to an existing suspension and/or suspension component must be communicated to and approved by the RUSH before being used in competition.

Front End

- A.) The front axle must be a straight, one-piece axle manufactured from magnetic steel tubing. No camber adjustable front axles.
- B.) Split axles and/or dropped axles and/or independent front suspension(s) will not be permitted.
- C.) All brackets on the front axle must be welded and/or bolted. Bird cages and/or sliders will not be permitted.
- D.) Front spindles must be non camber adjustable.
- E.) Bearing shafts that are made of steel are recommended.
- F.) The chassis may be offset a maximum of 4"-inches from the center of the inside tire width measured from the inside of the left front tire to the inside of the right front tire at axle height. Refer to the drawing in the back of this rule book regarding front and rear end offset details.
- G.) The front wheels and tires must remain fully exposed. Fenders and/or air deflection devices of any type will not be permitted.

Suspension Components

- A.) Independent front and/or rear suspensions will not be permitted.
- B.) A-Frames and/or ball joints will not be permitted for steering axis (kingpin only).
- C.) Four wheel steering, actuated by the steering wheel and/or of any type will not be permitted.
- D.) All suspension systems and designs must be mechanical. Hydraulic, pneumatic (air), electronic, radio and/or computer assisted for adjustments and/or in-or-out of cockpit type suspensions and/or suspension adjustment systems will not be permitted.
- E.) Traction control of any type, including within the braking system is not permitted.

G.) Must be a conventional style approved spring rod. No hydraulic spring rods permitted. Spring rods allowed on right rear radius rods only. No externally mounted shocks attached to radius rod. No rubber biscuits allowed on left rear radius rod.

H.) Droop limiters on left rear suspension will **NOT** be permitted.

I.) Only conventional-type aluminum bird cages currently being used are allowed. Maximum bracket thickness 1". No 3 or 4-bar rear suspension; no rear floating bird cages. Any new birdcage designs must be approved.

J.) The only materials used to fabricate axle housing mounts (birdcages) that will be permitted is aluminum or magnetic mild steel. Axle housing mounts fabricated of exotic, heavy materials will not be permitted.

K.) When fabricating axle housing mounts detail must be paid to functionality. The completed axle housing mounts, when comparing the right and the left side, must be as similar in design as possible.

L.) No front or rear sway bar assemblies.

M.) No left side panhard bar and No left side j-bar permitted.

N.) No 5th coil or shock control torque arm.

Rear Suspension Attaching (Radius) Rods

A.) The only materials used to fabricate attaching (radius) rods that will be permitted are magnetic steel or aluminum

B.) Aluminum attaching (radius) rods may be solid or tubular material. Magnetic steel attaching (radius rods) must be tubular with a maximum wall thickness of 3/16 inch.

C.) Only one radius rod per side permitted on rear suspension; minimum 27" center to center of rod ends.

Springs

A.) Torsion bar and/or coil over spring suspension only. No cantilever suspension permitted.

B.) Coil springs must be manufactured from magnetic steel.

C.) Stacked springs will not be permitted. Only one spring per shock; no dual, concentric, which is defined as a spring contained within the diameter of another spring, or stacked springs on any shock. Traditional take up springs will be permitted providing they carry no functioning rate (must be able to compress by hand) A progressive rated spring will be permitted.

D.) No external bump stops, bump rubbers, or bump springs of any kind on the shock shaft other than normal sized travel indicating o-rings. No coil spring or valve spring-type bump springs permitted. No convex disc bump spring permitted. No pneumatic or hydraulic bump stops permitted.

E.) No coil spring inserts.

F.) Spring preload adjustments for coil springs must be made using mechanical adjusting nuts on the shock body.

G.) Other than spring dampening by the shock absorber, hydraulic, pneumatic, or electrically controlled adjusting devices, (static or dynamic) that affect spring preload or race car heights will not be permitted.

H.) No frame-mounted snubbers, bump springs or traveling limiting devices permitted.

Shock Absorbers

A.) Shock absorbers are restricted to three part numbers manufactured by Bilstein on a proprietary basis for the RUSH Modified Series (sold at \$140). The only allowable part numbers are:

RUSH – 162-55 or 165-55 (Note each part # is identical valving)

RUSH – 162-90

RUSH – 208-72

B.) Only one (1) shock per wheel will be permitted.

C.) These sealed shocks do not have an external gas port; they are factory sealed. No attempt may be made to disassemble the shocks, or may shocks be altered in any way.

D.) Gas pressure may not be altered by drilling, addition of a visible gas port, a hidden gas port, or by any other means.

E.) These shocks are machine sealed via an external crimp in their sturdy steel body. Valving may not be altered by any means, and external inspection of the shock may not show that an attempt has been made to defeat the seal.

F.) Shock shafts may not be strategically bent to a pre-determined profile for the purpose of changing the shock's compression or rebound performance.

G.) Shock covers permitted, but must be removed for all technical inspections.

Series or Track Officials reserve the right to confiscate any shock from the car of any competitor for purposes of dyno testing. If the resulting graph of that specific shock fits Bilstein's valving and gas pre-load templates the shock will be returned to the owner. If any anomaly appears regarding external tampering evidence, or failure to fit the valving and gas-preload templates, the shock will be shipped to Bilstein and cut apart for examination of piston, valve stack, oil, and the body will be examined for drilled and hidden gas ports. If an alteration is detected Bilstein will photo document the valve stack, oil, or the alteration in the body to RUSH Series officials.

If, upon dyno testing and inspection, it is determined that the gas pressure, seals, piston, oil, shock tube, rod, or valving has been altered in any way, the shock absorber will be determined illegal and RUSH published penalties will apply.

RUSH Racing Series Officials reserve the right to technically inspect, exchange and/or confiscate any specified Bilstein sealed shock at any time. Failure to surrender the shock(s) and/or submit the shock(s) for inspection equals disqualification from the night's event, loss of all Series points to date, suspended from all RUSH-sanctioned Series competition for 365 days, and fined \$1,000.

Any violation of the RUSH Bilstein spec shock rule will result in the driver being disqualified for the night's event, loss of all Series points to date, suspended from all RUSH-sanctioned Series competition for 365 days, and fined \$1,000.

Brakes

A.) All cars must have four (4) wheel hydraulic brakes in good working condition. Random brake inspection may take place throughout the season.

B.) Carbon fiber, carbon, titanium, ceramic, aluminum pads and/or rotors will not be permitted.

C.) On live rear axles, one inboard and one outboard brake assembly will be permitted.

D.) Only a single brake bias adjustment will be permitted in the cockpit.

E.) Manual brake shut offs will not be permitted, with the exception of the right front brake.

F.) Rear brake calipers must be approved aluminum 4 piston design and must be operational. Maximum rotor diameter 12.19" diameter by 1.25" thick and must be vented. No solid rotors with the exception of the 3/8" rotor.

Wheels

A.) Only one-piece steel wheels will be permitted for competition. Maximum wheel weight is 28 lbs. Aluminum, magnesium, carbon fiber and/or any other exotic type material will not be permitted.

B.) Weights of any kind, added to wheels other than conventional balancing, are not permitted

C.) Wheel spacers must be aluminum

D.) Bleeder valves of any kind will not be permitted.

E.) The maximum rim width will be 14" inches when measured from the inside of left bead to the inside of the right bead of the wheel; however, it is *highly recommended* to use 12" wide on rear and 10" wide on front. Only wheels 15"-inches in diameter will be permitted.

F.) Only beadlocks on the outside of any wheel will be permitted. Any wheel utilizing a beadlock must maintain a minimum diameter hole of 11" or 5" inches inside the beadlock and the wheel. Beadlocks may only be used on the outside of the wheel. Aluminum beadlock "rings" permitted.

G.) Wheel covers and/or hubcaps will not be permitted on the inside of the wheel(s). Wheel covers and/or hub caps will be permitted on the outside of the wheel providing they are one piece, positively fastened to the wheel and/or beadlock, and maintain a minimum thickness of .090" with a minimum 1"-inch diameter hole in the center of the cover.

H.) Wheel covers: Only steel wheel cover fasteners permitted. It is highly recommended that wheel covers have a minimum of 5 mounting points. However, 5 and 3 mounting point wheel covers will be allowed for competition under the following conditions: Wheel covers having a minimum of 5 attachment points may continue to use steel dzus fasteners. Dzus fasteners must be made of steel only. Wheel covers having only 3 attachment points must be bolted-on at all 3 points utilizing a minimum 5/16", flanged steel bolt and an approved fastening (nut assembly) system. **No adjustable mounting rings allowed.**

Approved fastening (nut assembly) systems:

1. Precise Racing Products Part # WCBK
2. Keyser Manufacturing Part #100 7-101.
3. Wehrs Manufacturing Part # WM377A-312 Aluminum 5/16" / WM377S-312 Steel 5/16"
4. Triple X Chassis Part # SC-WH-7810(for a 1" spring) / SC-WH-7820 (for a 1 3/8" spring)
5. Smith Precision Products Part # MC-516-18

Optional fastening systems that are equal or superior to the above-approved system will be readily approved at the sole discretion of Technical Officials.

I.) Foam inserts are also permitted.

J.) A minimum of five (5) lug nuts on the rear wheels will be required. A minimum of three (3) lug nuts will be required on the front wheels. Knock off hubs of any type on any wheel will not be permitted.

Tires

A.) Only Hoosier Racing Tires will be permitted in any RUSH-sanctioned events. Hoosier (the tire manufacturer) will mark/stamp/brand all legal tires with specified compound and/or other specific RUSH designations as listed below;

Tire Size and Compound Designation:

Only the below listed Hoosier Racing Tires are approved for competition.

Front Tires:

- Hoosier 11.0/82.0-15 D300 compound

Rear Tires:

- Hoosier 11.0/87.0-15 M45 or D50
- Hoosier 11.0/90.0-15 M45 or D50

No other tires will be permitted.

B.) Series Officials may amend the tire rule for any event if track conditions warrant, and will inform competitors.

C.) The minimum rear tire pressure will be as follows; Left rear a minimum of 7lbs, right rear will be a minimum of 10 lbs. One-pound (1 lb.) tolerance for gauge fluctuation.

D.) The altering of any tire compound, by any means will not be permitted. Chemical alteration of the tread carcass and/or tread compound, such as tire 'soaking' and or the introduction of tread 'softener' and/or the physical defacement (removal, altering and/or covering) of tire sidewall markings in any manner will not be permitted. ***Tire samples not conforming to manufacturer's submitted factory benchmark will be deemed illegal.*** If any competitor is found to have altered their tires any penalty deemed appropriate by RUSH Officials may be issued.

1.) Any tire may be inspected and/or analyzed for alteration at any time, and may be confiscated. This will consist of a process as determined by the independent laboratory that performs the analysis. A "Chain of Custody" process will be outlined with the competitor upon inspection of the tires.

2.) The analysis process will require shipment of the tire sample(s) to the selected laboratory. Additional race event(s) may be completed before a determination is made. If a penalty is issued, the event(s) that fell into the analysis time period while the tire(s) were being analyzed will not be considered as part of the penalty time period.

3) **PENALTIES FOR ILLEGAL TIRES:** Disqualification from event (loss of points and money) in addition to the following penalties:

- First Offense: \$500 fine & 30-day suspension from any RUSH-sanctioned event plus all related lab testing costs.
- Second Offense: \$1,000 fine & 90-day suspension from any RUSH-sanctioned event plus all related lab testing costs.
- Third Offense: \$2,000 fine & 365-day suspension from any RUSH-sanctioned event plus all related lab testing costs.

Failure to allow any tire(s) to be confiscated for any reason by a RUSH Official will result in a \$750 per tire fine and 45-day suspension from all RUSH-sanctioned events in addition to any other fines and penalties. All decisions are final.

ALL DECISIONS ARE FINAL.

E.) Removable duct tape, provided it does not deface the tire, to cover the D-Number will be permitted.

F.) Heating of the tires by torch, blanket, heating device(s), exhaust system and/or any other method will not be permitted.

G.) Inner liners of any type will not be permitted.

Tread Width

A.) The maximum front tread width will be 86"-inches with a minimum of 74"-inches. The maximum rear tread width will be 86"-inches with a minimum of 74"-inches. These measurements will be taken from the outside edge of the sidewall of the tires on each side.

EXOTIC MATERIALS: All exotic materials are illegal, which includes titanium, tungsten and/or carbon fiber. EXCEPTION: carbon fiber driveshafts will be permitted for safety purposes as well carbon fiber seats provided they meet the 39.2 specifications. Magnesium rear end center section, bells, and rear cover will be permitted. No other magnesium parts will be permitted.

Personal Safety Equipment

General

A.) Each competitor is the solely responsible of for the effectiveness and proper installation, per the manufacturer's specifications, of personal safety equipment and determining it to be adequate for competition at every event. Each competitor is expected to investigate and educate themselves for continuing improvement regarding their own personal safety equipment.

B.) RUSH Rules regarding safety equipment are the minimum and you will not be permitted to compete if your safety equipment does not meet the RUSH rules. Many tracks and or states require additional safety equipment not mandated by RUSH. Be sure to familiarize yourself with the requirements of each track. RUSH-sanctioned tracks and/or any track hosting a RUSH event will be required to enforce the RUSH safety rules completely without exception.

Seat Belt/Restraint System

A.) Each car will be equipped with minimum five (5) point SFI 16.5 or SFI 16.1 approved restraint system, until the date of the belt expiration (two years from the date of manufacturer). Seat belt restraint systems shall be installed and used in accordance with manufacturer's instructions. Two inch (2"-inch) wide belts that meet the SFI 16.5 and/or SFI 16.1 specifications will be permitted.

B.) Seat belt material should not be permitted to come in contact with any sharp or metal edge, including when the material passes through the seat.

C.) Rolled and/or deburred and/or flanged edges or anywhere seat belt webbing passes through and may come in contact with abrasive edges are recommended.

Protective Clothing

A.) All drivers will be required to wear a fire resistant driving uniform meeting minimum of the SFI 3.2A/5 specification and display a valid SFI 3.2A/5 label.

B.) All drivers should wear fire resistant accessories including but not limited to; head sock, under garments, shoes, and socks. All drivers will be required to wear fire resistant gloves. Shoes and gloves will be required to meet minimum of the SFI 3.3 specifications and display a valid SFI 3.3 label.

Seats

A.) Effective 2019:

Seats must be "Full Containment" style constructed of aluminum to the general design specifications of current industry standards, (SFI 39.2 highly recommended). Design shall include comprehensive head surround, shoulder and torso support system, energy impact foam, and removable head foam. Consult with your seat manufacturer for questions and recommendations regarding your seat safety system.

Seats manufactured using carbon fiber or composite materials must meet SFI 39.2 specifications.

Up-fitting an existing seat with bolt-on kits will be permitted with a seat manufacturer-produced kit and an acceptable base seat approved by the seat manufacturer. Consult with your seat manufacturer for recommendations regarding your current seat. If Left Head Surround does not exceed 7 inches from the back of the headrest, a left side seat net meeting SFI specifications is required.

B.) All areas surrounding the head should have padding.

C.) The driver's seat must be securely fastened to the frame and/or cage in six positions with a minimum of six (6) 3/8"-inch bolts. There should be a minimum of four (4) bolts on the bottom and two (2) in the back of the seat. All seats must be a minimum of 1/8"-inch magnetic steel plate under and up the back 4" inches and be as wide as the seat. Only single piece high back type seats will be permitted.

Helmets

A.) All drivers must wear a full-face helmet with a minimum safety rating of FIA 8860-2010, Snell SA 2015, Snell SA 2010, Snell SAH 2010, and/or a valid SFI 31.1/2005 label.

B.) It is recommended that helmets should be fitted with the Eject™ helmet removal system.

C.) Head and neck restraints will be mandatory and must be SFI 38.1 approved and display a legible and valid SFI 38.1 label. The head and neck restraint system must be mounted and connected to the helmet per the helmet manufacturer and head and neck manufacturer instructions.

D.) Arm restraints are recommended and must be connected and used as instructed by the manufacturer.

Other General Safety Items

A.) Sharp and/or protruding edges in and around the cockpit will not be permitted.

B.) Windshield screens should be a minimum thickness of 0.090 inch and should be securely fastened to the roll cage.

C.) A clearly marked electrical engine shut-off switch within the reach of the driver.

D.) A clearly marked fuel shut off valve, labeled On and Off, must be mounted within reach of the driver. It must be labeled with the word(s) "Fuel Shut Off". Refer to the drawing in the drawing section of this rule book.

E.) Roll bar padding mandatory. Other cockpit padding, knee and steering pads recommended. All padding must be fire resistant.

F.) All cars must have a driveline U-Joint scatter shields.

G.) It is highly recommended all teams must have a fire extinguisher in the rear of their transporter with the car number clearly visible on the extinguisher. It is highly recommended the fire extinguisher be a minimum of 20lbs and is recommended to FFF type chemical and/or Dupont FE-36 and/or equivalent.

Other

A.) All cars may be subject to technical inspection at any time. Any driver fails to cooperate and/or allow an inspection of his car at any time will be subject to disqualification and/or fine and/or suspension and/or any other action deemed appropriate by the RUSH Series Officials.

B.) All fuel lines, power steering lines and/or fittings running through the driver's compartment must be made from an approved braided type line. Plastic and/or glass fuel filters will not be permitted.

C.) SFI-approved and labeled seat, roll bar, knee and steering pads and/or padding is recommended.

D.) All drivers are required to have a one-way radio. The one-way radio must be working and active prior to any 'on-track' activity. Two-way radios, crew-member to driver and/or any other means of electronic communication, other than the one-way radio *will not* be permitted.

E.) Transponders are mandatory at tracks and events that require them.

GENERAL CAR INSPECTION:

All cars may be subject to technical inspection at any time. Any driver that fails to cooperate and/or allow an inspection of his car at any time will be subject to disqualification, a 45-day suspension, and \$750 fine.

Full or partial car covers will be permitted only when there is inclement weather.

Rear car covers are permitted, but must be removed prior to leaving pit stalls. No covers of any kind under the car or covering wheel openings. Each team will receive one (1) verbal warning for the season. A second infraction will result in a loss of warm-ups, a loss of a qualifying lap, or placement to the tail of your next scheduled event, depending upon when said second infraction occurs.

FINES, PENALTIES, SUSPENSIONS & APPEALS

PRE-RACE TECHNICAL VIOLATION:

If a technical violation(s) is found during pre-race technical inspection, the driver/team will be advised of the violation and must meet full compliance before being allowed to compete.

REFUSAL OF TECH

A refusal of tech and/or failure to allow an official to confiscate a part(s), other than the already previously stated individual refusal penalties/suspensions, will result in a 45-day suspension and \$750 fine. All illegal parts will be confiscated.

FINES & PENALTIES:

If an entrant is disqualified for any reason, any fine and /or suspension applies to both the driver and car owner if not the same person. In other words, if an entrant is disqualified for a technical violation, such as an engine not in compliance with tech specs, neither the owner nor the driver can race for the suspension period, and while only one fine will be charged, neither party can race until that fine is paid. Fine must be paid in full to Series by cash or certified check in order to compete once suspension period ends. NOTE: If suspension includes 'a number of days' clause and occurs at the end of the season when no additional events exist, suspension will carry over to the following year beginning with the first RUSH-sanctioned event in the region.

EVENT SUSPENSIONS:

Driver/Owner suspended for any infraction will carry over to **ALL** RUSH-sanctioned divisions and will preclude driver/owner from competing at **ANY** RUSH-sanctioned event until suspension is lifted.

MULTIPLE INFRACTIONS:

In the event driver and/or car is disqualified in post-race tech for the same technical rules infraction twice (excluding engines within the sealing system, tires, fuel, and shocks, springs, suspensions rules- see each rule for specific penalties), driver and car will be suspended for 7 days from all RUSH-sanctioned events. Each successive infraction will carry an additional 7-day suspension.

In the event an entrant fails technical inspection for multiple infractions that each carry a suspension and/or fine at the same event, suspension and/or fine will compound and accumulate with each infraction.

LEGALITY OF PARTS:

If RUSH or Track Tech Inspector is unsure of the legality of a part, said part will be sent to GM or to RUSH Office for inspection. At this time, finishing position will be frozen until legality of said part is determined. In the event of a disqualification, finishing position, points and monies would be adjusted accordingly. **ALL ILLEGAL PARTS WILL BE CONFISCATED & DESTROYED!** Not allowing confiscating of parts is considered "cheating within the bolts" and said penalties will be imposed.

FINALITY OF DECISIONS AND INTERPRETATIONS AND COVENANT NOT TO SUE:

The decisions of RUSH officials or promoter at an event, including the interpretation and application of rules and the scoring of positions, shall be FINAL, BINDING, and NON-APPEALABLE, except in the case of a suspension or fine, which is further explained in the SUSPENSIONS/FINES & APPEALS category.

All participants, as a condition of participating in an event, agree that ALL decisions of officials or the promoter, regarding the interpretation and application of the rules, and the scoring of positions, shall be NON-LITIGABLE. All participants further covenant and agree that they will NOT initiate any of legal action against Great Crate Racing Northeast D/B/A RUSH Racing Series, the promoter, and officials to challenge such decision, to seek monetary damages, to seek injunctive relief, or to seek any kind of legal remedy. If a participant pursues any such legal action, which violates this provision, then the participant and/or owner expressly agrees to reimburse RUSH for ALL of its ATTORNEY FEES and COSTS IN DEFENDING AGAINST SUCH LEGAL ACTION.

By signing the annual registration agreement, participants agree that they will comply with the written rules and procedures of RUSH. In the event that he or she would breach the registration agreement, he or she shall be liable for actual and liquidated damages sustained by RUSH Racing Series.

APPEALS PROCESS:

RUSH will determine any and all suspensions/fines that are covered in the rules and any violation that may come up during the year. RUSH will make judgment on the sanctions, and violator(s) will be sent official notice by a certified letter, return receipt requested.

Driver and/or car owner has the opportunity to appeal his or her sanction and must do so in writing accompanied by any relevant documentation. Appeal must be in writing and faxed or e-mailed to the RUSH Office at 724-964-0604 or within 48 hours of notification of violation.

RUSH will then set a date and time for the appeal hearing at the business office located at the address of 4368 Route 422, Pulaski, PA 16143. The violator(s) will present his/her case to the RUSH Racing Series. The violator(s) and one other person is permitted to attend the appeal hearing. Additional attendees must be approved by RUSH pursuant to a written request.

Following the appeal hearing with the violator(s), RUSH may conduct further follow-ups, meetings, etc. with any other necessary party(s). Judgment will then be rendered to the violator by a certified letter, return receipt.

Violator(s) agrees that the decision made will be final and party posting appeal has no legal rights thereafter. In the event of a protest, the party that protested also agrees to accept final ruling on decision and has no legal rights thereafter.

AMB TRANSPONDER

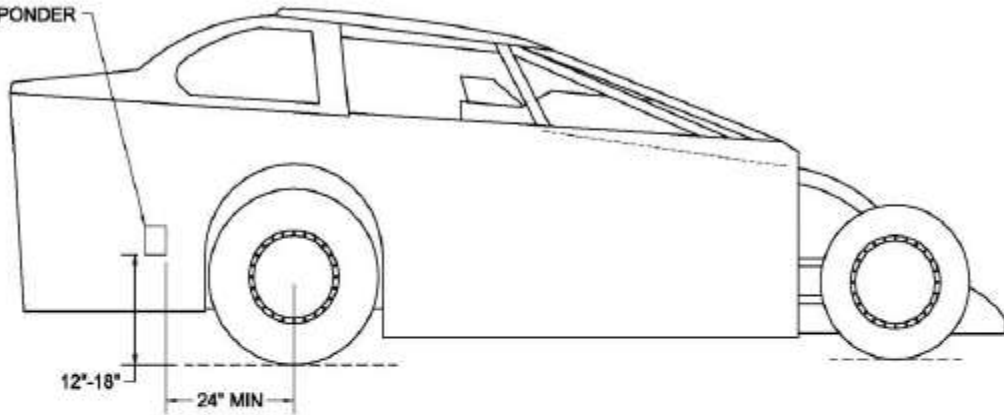

Transponders must be mounted on the inner right side sheet metal surrounding the fuel cell no less than 24" behind the rear axle centerline at a height of 12" to 18" from the ground. For optimum function, the transponder should be mounted as close to the ground as possible. Transponder must be mounted vertically with no obstruction between the transponder and the ground. It is recommended that a shield be installed in front of the transponder for protection from clay and debris. The shield can not be made of metal or carbon fiber. If using a rechargeable transponder with a mounting bracket, it is recommended that additional support like a tie wrap or similar be used. Do not rely solely on the cotter pin.

WORLD RACING
GROUP

TRANSPONDER LOCATION

DWG #: 7.1.3

Body Dimensions

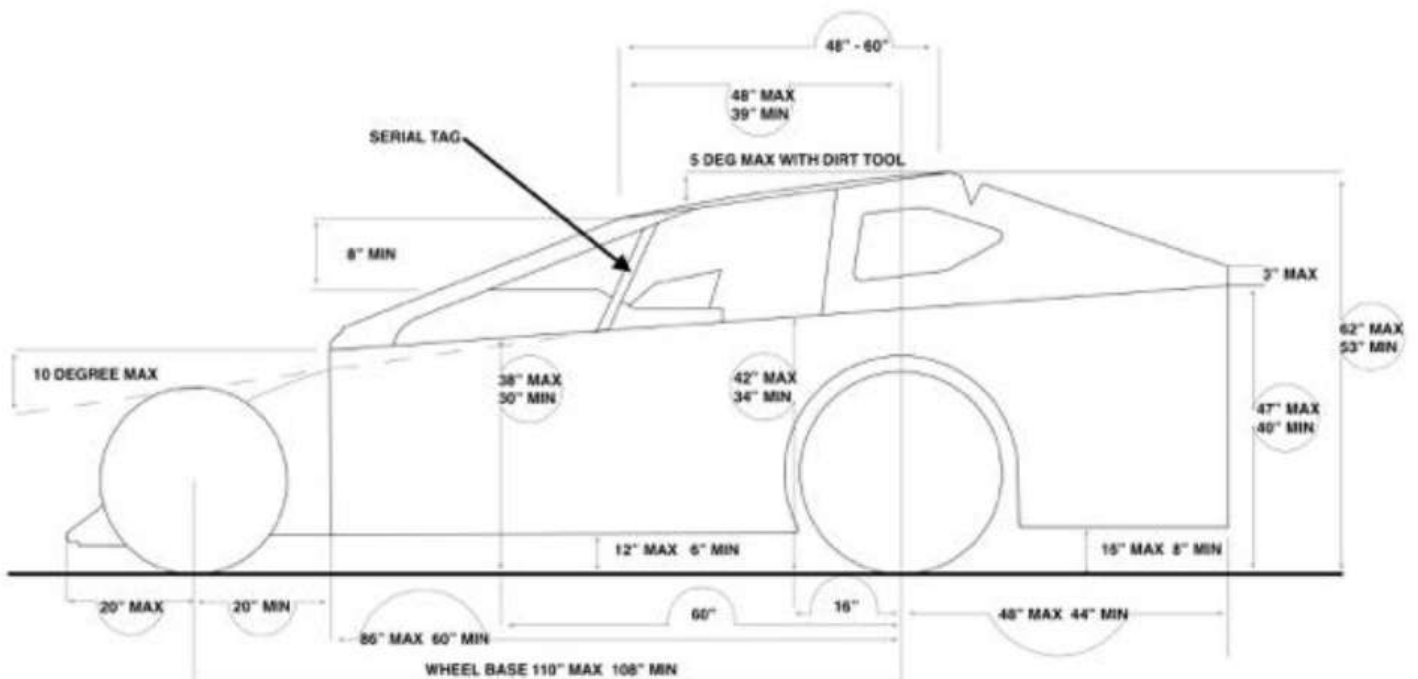

Rear Body Dimensions

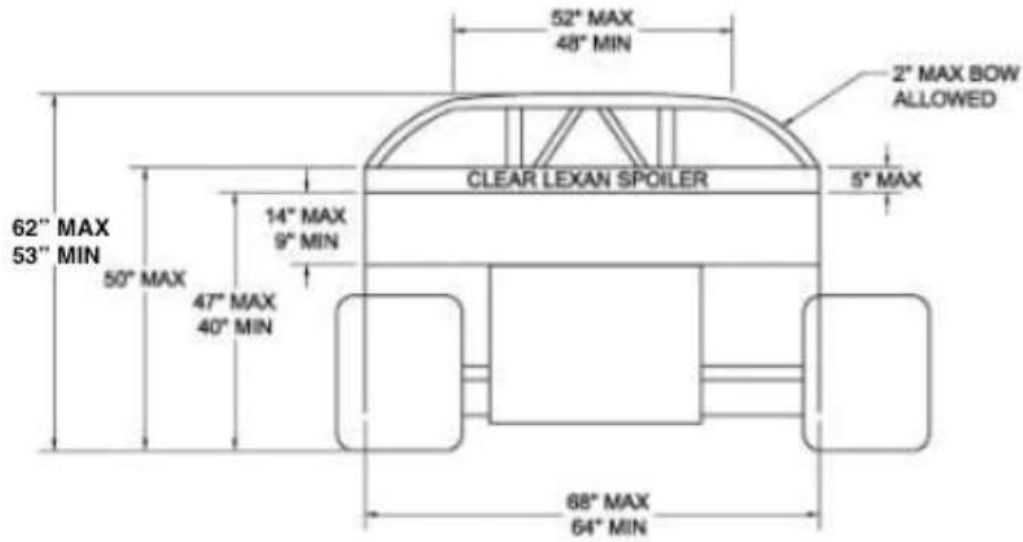

WORLD RACING GROUP	MODIFIED BODY DIAGRAM	
	VIEW: REAR	DWG #: 448

Roof Profile:

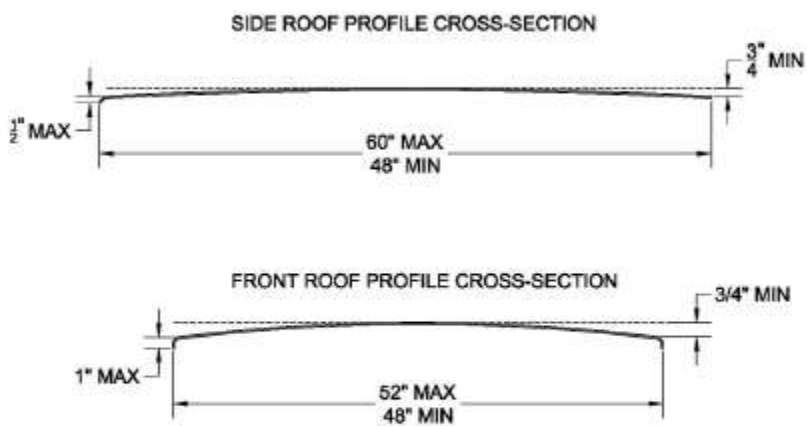

REVISION B:
2/24/05, 1 1/4" DIMENSION
CHANGED TO 3/4".

Bumpers:

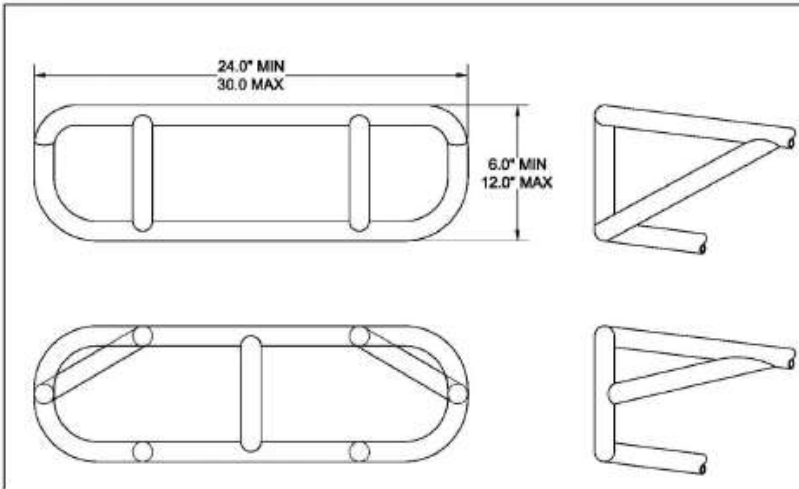

NOTE:
 BUMPERS MUST BE CONSTRUCTED
 OF 1 1/4" X 0.095 TUBING AND
 MAINTAIN A HEIGHT OF 18"
 MEASURED FROM THE GROUND TO
 THE MIDDLE OF THE BUMPER

Chassis Diagram:

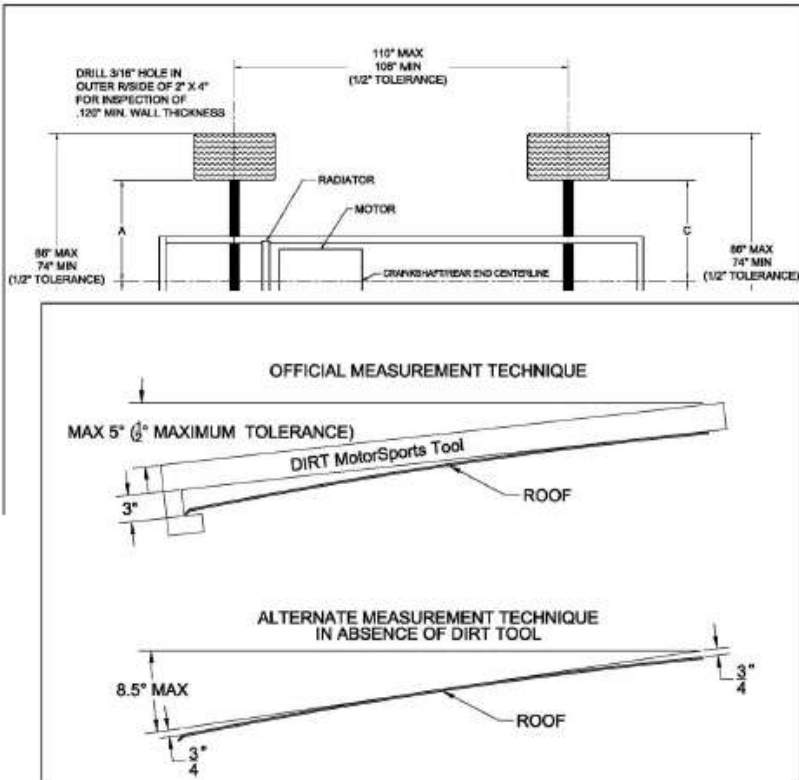

Fuel Cell Straps:

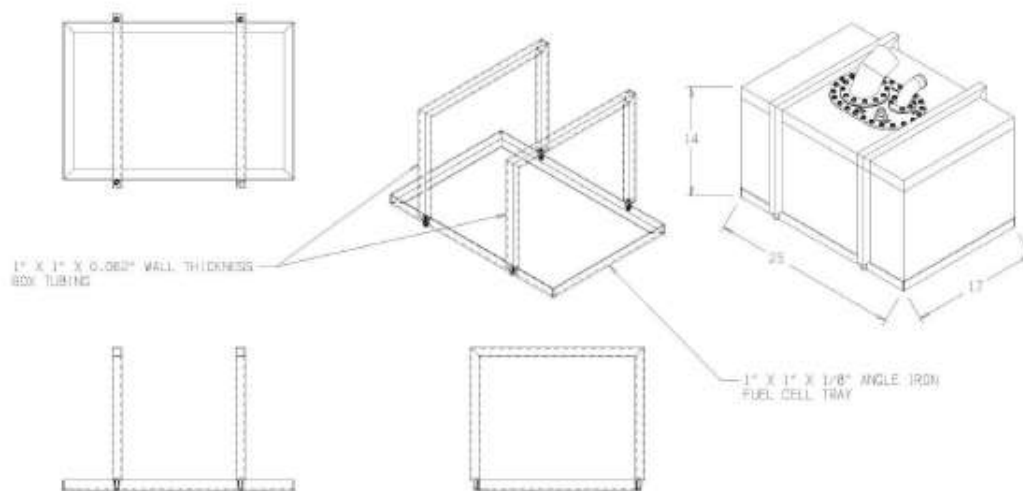

Fuel Cell:

Do not take measurements at the top lid, as it will always be bigger to fit over the canister! The numbers will vary with different shape cells!

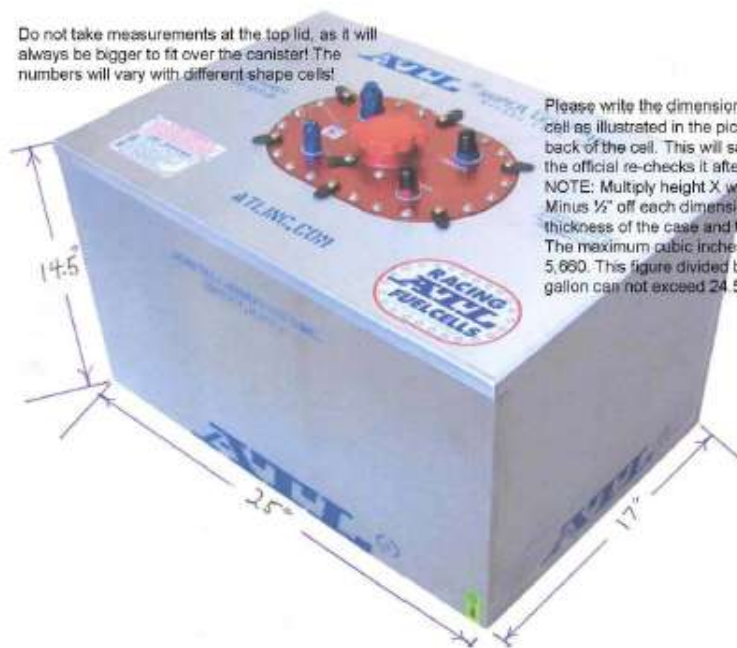

Rub Rail:

Rubrail:

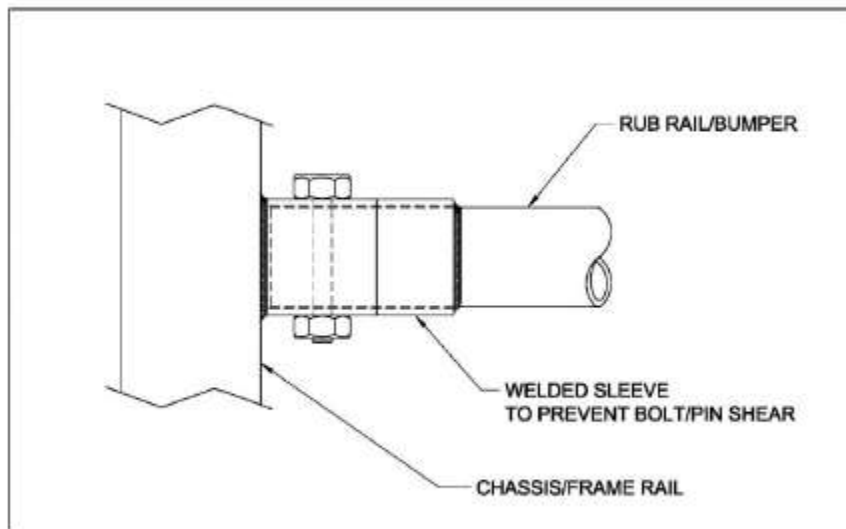

Rev. 2/19/19